



TU ALIADO EN ACERO

CATÁLOGO
2024



aceros lasa

Con un equipo de trabajo especializado en el conocimiento del Acero y en las necesidades de nuestros clientes; comunicamos e innovamos en cada oportunidad para satisfacer las necesidades de materiales para la construcción de tus proyectos.

NUESTRO COMPROMISO

Consolidarnos como una empresa comprometida con las necesidades que demanda la industria del acero y de la construcción.

MISIÓN

Comercializar productos de calidad para satisfacer las necesidades de nuestros clientes, ofreciendo excelente servicio a precios competitivos.

VISIÓN

Ser la mejor opción en el ramo del acero y ferretero, destacando por nuestro servicio y calidad de nuestros productos.





CONTENIDO

LÍNEA DE HERRAJES	2
LÍNEA DE CORTINAS	9
LÍNEA DE CERRADURAS	14
LÍNEA DE CANDADOS	19
LÍNEA DE HERRAJES DECORATIVOS.....	22
LÍNEA DE PINTURAS Y ACCESORIOS.....	45
LÍNEA DE CINTAS Y SELLADORES.....	51
LÍNEA DE ABRASIVOS, CORTE Y DESBASTE.....	54
LÍNEA DE SEGURIDAD.....	64
LÍNEA DE MALLAS Y ACCESORIOS.....	70
LÍNEA DE MATERIAL DE CONSTRUCCIÓN.....	74
LÍNEA DE ACERO ESTRUCTURAL.....	78
LÍNEA DE ACERO DE HERRERÍA	87
LÍNEA DE PLANOS Y LÁMINAS	116
LÍNEA DE METAL DESPLEGADO	126
LÍNEA DE HERRAMIENTAS Y ACCESORIOS.....	138



23

LÍNEA DE HERRAJES

BISAGRAS DE PROYECCIÓN



BISPROY

BISAGRA DE PROYECCIÓN (SENCILLA)

Bisagra de proyección fabricada en lámina de acero calibre #12 y #13. Acabado en Negro.
USO: Para ventanas de perfil tubular.

BISAGRA DE LIBRO 830



BISLIBRO1

BISAGRA DE LIBRO 830 STAND

Bisagra de proyección fabricada en lámina de acero calibre #12 y #13. Acabado en Negro.
USO: Para ventanas de perfil tubular.

BISAGRA TUBULAR NEGRA



BITUNE3/8	BISAGRA TUBULAR NEGRA 3/8"
BITUNE1/2	BISAGRA TUBULAR NEGRA 1/2"
BITUNE3/4	BISAGRA TUBULAR NEGRA 3/4"
BITUNE5/8	BISAGRA TUBULAR NEGRA 5/8"
BITUNE1v	BISAGRA TUBULAR NEGRA 1"

Bisagra tubular negra fabricada en redondo de acero 1018 y Cold roll.

USO: Puertas metálicas ligeras.

PLACAS PARA BUZÓN



PLABUALES

PLACA BUZÓN ALUMINIO ESP

PLABUBR

PLACA BUZÓN BRONCE 190 MM

Tapa para buzón con diseño europeo.

CAJA PARA BUZÓN



CABUCHI

CAJA BUZÓN CHICA

CABUME

CAJA BUZÓN MEDIANA

Caja buzón metálica de lámina de acero calibre #22. Tamaño Chico (21 cm x 34cm), Mediana (21cm x 34cm). Ideal para puertas y portones.

Todas nuestras carretillas brindan un movimiento ligero y silencioso, además de ser de fácil colocación.

CARRETILLA MOD. 22



CA22CR

CARRETILLA 22 1 BALERO CR

Carretilla galvanizada de 1 rueda de lámina de acero cal. #16 con rueda embalada de acero redondo de 7/8".
USO: Para puertas y ventanas metálicas y de madera.
Capacidad de 10kg.

CARRETILLA 2R



CARRET2R

CARRETILLA 2 R

Carretilla de 2 ruedas mod. 16.5 o 7000 para riel aéreo tipo U. Fabricado en cuadrado de acero 5/8" y llanta de cold roll redondo de 15/16", contra de lámina calibre #16. Acabado Galvanizado.

USO: para cancelas, puertas metálicas, de madera o de aluminio corredizas. Capacidad de 40kg.

CARRETILLA MOD. 10.5



CARRET1R

CARRETILLA 1R

Carretilla de lámina de acero cal.16 con rueda embalada de acero redondo 15/16" en acabado galvanizado.
USO: Para perfil metálico en ventanas y rieles para closets.

CARRETILLA MOD. 16 U 8000



CARRET4R

CARRETILLA 4R

Carretilla de cuadrado de acero 5/8" y llantas cold roll redondo de 15/16" y contra lámina cal. 16 en acabado galvanizado.

CARRETILLA MOD. 10



CA10ES

CARRETILLA No. 10 ESCUADRA

CA10RE

CARRETILLA No. 10 RECTA

Carretilla de lámina de acero Cal. 14 con rueda embalada de acero redondo 15/16" en acabado galvanizado
USO: Para perfil metálico en ventanas y rieles para closet.

CARRETILLA WILCOTT



CAWIEM

CARRETILLA WILCOTT EMBALADA REFORZADA

Carretilla de 4 ruedas wilcott mod. 9051 o 9100 embalada de cuadrado, de cuerpo de acero cuadrado de 3/4" con rueda embalada de acero cold roll 2". Acabado Galvanizado.

USO: Para portón metálico, Capacidad de carga 450kg.

CARRETILLA MOD. 18



CA184B	CARRETILLA 18 4 BAL. ACERO
CA184BNY	CARRETILLA 18 4 BAL. NYLON

Carretilla de acero calibre 14 con rueda embalada, para riel tipo T en acabado galvanizado.
Capacidad de carga máxima 50 kg. por juego
USO: Puertas tipo closet.

CARRETILLA MOD. 18.5



CA181/22B	CARRETILLA 18 1/2 2 BAL. ACERO
-----------	--------------------------------

Carretilla de lámina de acero calibre 14 con rueda embalada para riel tipo T, acabado galvanizado.
Capacidad de carga máxima 25 kg. por juego
USO: para puertas de madera tipo closet.

Todos nuestros cerrojos son fabricados con los mejores materiales. Manejamos en acabado galvanizado y colonial.

Cerrojo tipo Mauser galvanizado, fabricado en lámina de acero Calibre 14,16 y 18.
USO: Ideal para puertas de madera o metal de casa, bodegas, garaje, etc.

TROLE DOGOTULS



TRDO250	TROLE DOGOTULS 250 KGS.
TRDO500	TROLE DOGOTULS 500 KGS.
TRDO1000	TROLE DOGOTULS 1000 KGS.
TRDO2000	TROLE DOGOTULS 2000 KGS.
TRDO3000	TROLE DOGOTULS 3000 KGS.
TRDO5000	TROLE DOGOTULS 5000 KGS.

Trole de acero para carga, diferentes capacidades.

CARRETILLA MOD. 31



CA31GLE	CARRETILLA 31 RIEL GLEIRO
---------	---------------------------

Carretilla de lámina de acero en acabado galvanizado para riel Gleiro. Medida 30 x 30 mm.
Capacidad de carga máxima: 10 kg. por juego
USO: Para puertas de madera tipo closet.

CERROJO TIPO MAUSER GALVANIZADO

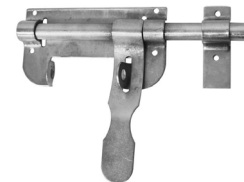

PAMA50	CERROJO TIPO MAUSER R-50 GALVANIZADO
PAMA100	CERROJO TIPO MAUSER R-100 GALVANIZADO
PAMA150	CERROJO TIPO MAUSER R-150 GALVANIZADO
PAMA250	CERROJO TIPO MAUSER R-250 GALVANIZADO
PAMA300	CERROJO TIPO MAUSER R-300 GALVANIZADO
PAMA350	CERROJO TIPO MAUSER R-350 GALVANIZADO
PAMA350S	CERROJO TIPO MAUSER R-350 GALV. SOLIDO

CERROJO TIPO MAUSER COLONIAL



**Producto SOBRE PEDIDO

PAMA100CO	CERROJO TIPO MAUSER R-100 COLONIAL
PAMA150CO	CERROJO TIPO MAUSER R-150 COLONIAL
PAMA250CO	CERROJO TIPO MAUSER R-250 COLONIAL
PAMA300CO	CERROJO TIPO MAUSER R-300 COLONIAL
PAMA350CO	CERROJO TIPO MAUSER R-350 COLONIAL

Cercojo para portón tipo Mauser colonial de lámina de acero calibre 14 y redondo 15/8". Acabado en esmalte negro.
USO: Portones metálicos o de madera.

PASADOR PLANO



PASP050	PASADOR PLANO CHICO P050
PASP150	PASADOR PLANO GRANDE P150
PASP100	PASADOR PLANO MEDIANO P100

Pasador plano de acero troquelado
USO: Para puertas metálicas y de madera en acabado galvanizado.

JALADERA ESTRIADA



**Producto SOBRE PEDIDO

Ja13009	JALADERA ESTRIADA ALUMINIO
---------	----------------------------

Jaladera estriada de tubo de aluminio, de 20cm.
ACABADO: Anodizado blanco, bronce, duranodik, negro, café, natural y oro.
USO: Para puertas metálicas y de aluminio.

PASADOR DE PISO GALVANIZADO



PAPIA 30	PASADOR DE PISO No. A 30
PAPIA 40	PASADOR DE PISO No. A 40
PAPIA 60	PASADOR DE PISO No. A 60

Pasador de piso de lámina troquelada de cuadrado de 1/2" acabado galvanizado.
USO: Para puertas exteriores con portacandado.

PASADOR DE PISO COLONIAL



PACOA30REFM	PASADOR COLONIAL DE 30 REF
PACOA40REFM	PASADOR COLONIAL DE 40 REF
PACOA50REFM	PASADOR COLONIAL DE 50 REF
PACOA60REFM	PASADOR COLONIAL DE 60 REF

Pasador de piso colonial de cuadrado de 1/2" pintado, reforzado.
USO: Para rejas, portones y zaguanes con portacandado.

JALADERA TRENZADA



**Producto SOBRE PEDIDO

JATRAZ	JALADERA TRENZADA AZUL
JATRDO	JALADERA TRENZADA DORADA
JATRNA	JALADERA TRENZADA NATURAL
JATRNE	JALADERA TRENZADA NEGRA
JATRRRO	JALADERA TRENZADA ROJA
JATRVE	JALADERA TRENZADA VERDE

Jaladera de aluminio trenzada de 20 cm.
ACABADO: Anodizado, Oro natural, Verde, Azul, Rojo, Negro y Café.
USO: Para puertas metálicas y de aluminio.

JALADERA DE VENTANA CORREDIZA



JABLVE	JALADERA BLANCA. VENT CORRED
JADOVE	JALADERA DORADO. VENT CORRED
JANAVE	JALADERA NATURAL VENT CORRED
JANEVE	JALADERA NEGRO VENT CORRED

Jaladera de aluminio acabado en blanco, negro, natural y dorado. Medidas de 12 a 18cms.

USO: Puertas y ventanas corredizas de aluminio.

MANIJA COMBINADA



MACO11D	MANIJA COMBINADA No. 11 DER.
MACO11I	MANIJA COMBINADA No. 11 IZQ.

Manija de bronce con respaldo y contras de lámina en calibre 16 en acabado pulido.

USO: Para ventanas de perfil de acero.

MANIJA DE LÁMINA



MALA22D	MANIJA DE LÁMINA 22 DERECHA
MALA22I	MANIJA DE LÁMINA 22 IZQUIERDA

Manija en lámina de acero cal. 20 con respaldo y contra de lámina en cal. 16.

USO: Para ventanas de perfil de acero.

MANIJA DE BRONCE



MANBCED	MANIJA BRONCE DERECHA
MANBCEI	MANIJA BRONCE IZQUIERDA

Manija para ventana de bronce con respaldo y contras de lámina cal. 16. Acabado pulido.

USO: Para ventanas de perfil de acero.

PIJA PUNTA DE BROCA



TPPBAT1A	PIJA PUNTA BROCA GALVANIZADA TRAD. ARMADA 1
TPPBAT112A	PIJA PUNTA BROCA GALVANIZADA TRAD. ARMADA 1 1/2
TPPBAT114A	PIJA PUNTA BROCA GALVANIZADA TRAD. ARMADA 1 1/4
PIJAPB3X25	PIJA PUNTA BROCA GALVANIZADA TRAD. ARMADA 1/4 X 3
TPPBAT2A	PIJA PUNTA BROCA GALVANIZADA TRAD. ARMADA 2
TPPBAT34A	PIJA PUNTA BROCA GALVANIZADA TRAD. ARMADA 3/4

Pija de acero bajo al carbón 1019 armada, en acabado galvanizado.

MEDIDAS: 10 al 14 de diámetro y de 3/4" hasta 2" de largo.

USO: Para fijación de láminas de techo.

REMACHES DE CLAVOS DE ALUMINIO



PENDIENTE	PENDIENTE
-----------	-----------

Remaches con cabeza de aluminio y clavo de acero, diferentes medidas.

USO: Para fijación.

NUMEROS DE BRONCE



NUCHIBR	NUMERO DE BRONCE CHICO
NUMEBR	NUMERO DE BRONCE MEDIANO
NUGRBR	NUMERO DE BRONCE GRANDE

Números de bronce pulido de uso ornamental exterior. Medidas: Chico (6.4cm) Mediano (9.4cms) y especial (9.0cms).

ARO TOCA PUERTA



ARTO115	ARO TOCAPUERTA 1" DE 15 CM.
ARTO120	ARO TOCAPUERTA 1" DE 20 CM.
ARTO251"	ARO TOCAPUERTA 1" DE 25 CM.
ART 3/4 15	ARO TOCAPUERTA 3/4" DE 15 CM.
ART 3/4 20	ARO TOCAPUERTA 3/4" DE 20 CM.
ART 3/4 25	ARO TOCAPUERTA 3/4" DE 25 CM.
ART 5/8 20	ARO TOCAPUERTA 5/8" DE 20 CM.

Aro toca puerta fabricado con redondo de fierro negro, con diseño colonial.

USO: Ornamental en puertas metálicas exteriores.

TOCA PUERTA



TOPUCH	TOCA PUERTAS CHICO
TOPUGR 1	TOCA PUERTAS GRANDE RED 1

Toca puertas con placa calibre 11 y redondo de fierro, acabado natural.

BIBEL



BIMI	BIBEL CHICO CON BALERO 1/4" X 1 1/2"
BIBMED	BIBEL MEDIANO CON BALERO 1/4" X 2"
BIGI	BIBEL GIGANTE CON BALERO 1/4" X 3"
BIMEGI	BIBEL MEGA GIGANTE CON BALERO 1/4" X 4"

Bibel con balero fabricado en solera de acero troquelada. USO: Pivote superior para giro de puertas metálicas y zaguanes.

BIBEL DE PERNO O GOZNE



GOZ01	GOZNE
--------------	-------

Bibel fabricado en solera de acero troquelada en acabado galvanizado, tropicalizado y pintado.

USO: Pivote superior de giro para puertas metálicas de mediano peso.

TEJUELO



TENE 1	TEJUELO NEGRO DE 1"
TENE 1 1/4	TEJUELO NEGRO DE 1 1/4"
TENE 1 1/2	TEJUELO NEGRO DE 1 1/2"
TENE 2	TEJUELO NEGRO DE 2"
TENE 2 1/2	TEJUELO NEGRO DE 2 1/2"
TENE 3	TEJUELO NEGRO DE 3"
TENE 4	TEJUELO NEGRO DE 4"

Tejuelo de acero pulido para puertas y zaguanes abatibles.



LÍNEA DE CORTINAS

CORTINA DE ACERO ENROLLABLE

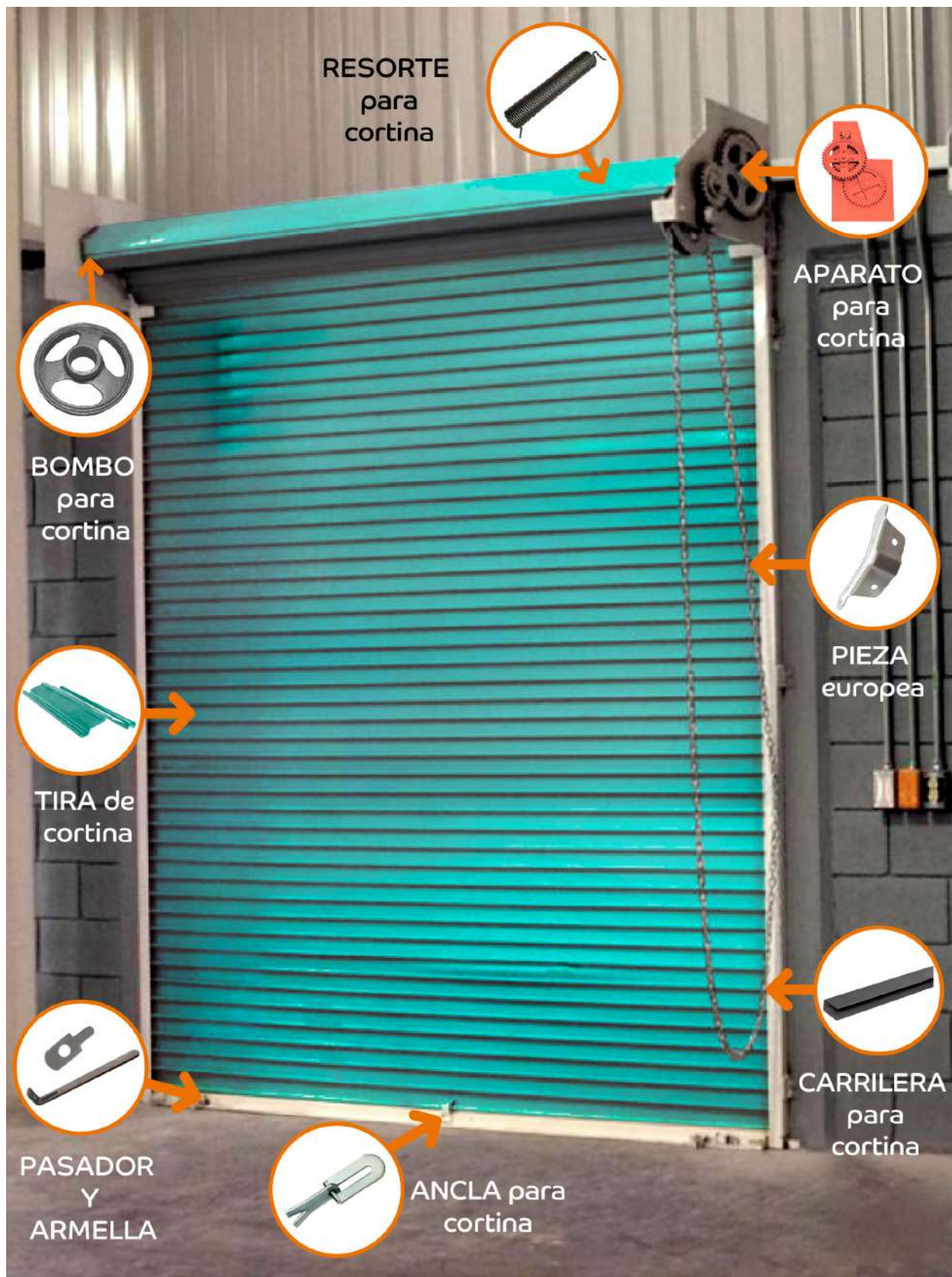

TIRA PARA CORTINA EUROPEA



TIRZ200	TIRA P/CORT EUROPEA ZINTRO 2.00 (1.32)
TIRZ205	TIRA P/CORT EUROPEA ZINTRO 2.05 (1.36)
TIRZ255	TIRA P/CORT EUROPEA ZINTRO 2.55 (1.70)
TIRZ305	TIRA P/CORT EUROPEA ZINTRO 3.05 (2.03)
TIRZ355	TIRA P/CORT EUROPEA ZINTRO 3.55 (2.35)
TIRZ405	TIRA P/CORT EUROPEA ZINTRO 4.05 (2.70)
TIRZ455	TIRA P/CORT EUROPEA ZINTRO 4.55 (3.04)
TIRZ505	TIRA P/CORT EUROPEA ZINTRO 5.05 (3.37)
TIRZ555	TIRA P/CORT EUROPEA ZINTRO 5.55 (3.71)
TIRZ605	TIRA P/CORT EUROPEA ZINTRO 6.10 (4.00)
TIRZ705	TIRA P/CORT EUROPEA ZINTRO 7.05 (5.00)

Tira para cortina europea zintro de diferentes medidas.

ANCLA PARA CORTINA



ANCO	ANCLA PARA CORTINA
------	--------------------

Ancla para cortina galvanizada.

RESORTE PARA CORTINA



RESORTE25DCHICO	RESORTE 25 CM. DIAMETRO CHICO
RESORTE30DCHICO	RESORTE 30 CM. DIAMETRO CHICO
RESORTE30DGDE	RESORTE 30 CM. DIAMETRO GRANDE
RESORTE35DCHICO	RESORTE 35 CM. DIAMETRO CHICO
RESORTE35DGDE	RESORTE 35 CM. DIAMETRO GDE
RESORTE40DCHICO	RESORTE 40 CM. DIAMETRO CHICO
RESORTE40DGDE	RESORTE 40 CM. DIAMETRO GDE
RESORTE45DCHICO	RESORTE 45 CM. DIAMETRO CHICO
RESORTE45DGDE	RESORTE 45 CM. DIAMETRO GDE
RESORTE50DGDE	RESORTE 50 CM. DIAMETRO GDE
RESORTE60DCH	RESORTE 60 CM. DIAMETRO CH
RESORTE60DGDE	RESORTE 60 CM. DIAMETRO GDE

Resorte de torsión para cortina con gran flexibilidad y resistencia.

ARMELLA



ARCO	ARMELLA PARA CORTINA
------	----------------------

Armella para portacandados en cortinas metálicas, fabricada en solera de acero al carbón A-36 troquelada. Medidas 1/4" x 1 x 6.5 cm de largo. Color negro.

BALA PARA BOMBO



BABO	BALA PARA BOMBO
------	-----------------

Bala para bombo troquelado de acero 1018 bajo carbón. Acabado natural, se utiliza como rodamiento para bombo troquelado.

BOMBO TROQUELADO



BOTR1	BOMBO TROQUELADO DE 1"
BOTR11/4	BOMBO TROQUELADO DE 1 1/4"
BOTR11/2	BOMBO TROQUELADO DE 1 1/2"

Bombo embalado troquelado de lámina. Medidas de 1" hasta 1 1/2" y diámetro de 7".
USO: Cortinas metálicas exteriores.

BOMBO DE FIERRO FUNDIDO



BO1	BOMBO FO. FO. DE 1
BO11/2	BOMBO FO. FO. DE 1 1/2"
BO11/4	BOMBO FO. FO. DE 1 1/4"

Medidas de 1" hasta 1 1/2" y diámetro de 6".
USO: Cortinas metálicas exteriores.

BOMBO DE ALUMINIO



BOAL1	BOMBO ALUMINIO 1"
BOAL11/4	BOMBO ALUMINIO 1 1/4"
BOAL11/2	BOMBO ALUMINIO 1 1/2"

Bombo de aluminio. Medidas de 1" hasta 1 1/2" y diámetro de 6".
USO: Cortinas metálicas exteriores.

BOMBO EMBALADO



BOEM1	BOMBO EMB. BALERO 1"
BOEM11/4	BOMBO EMB. BALERO 1 1/4"
BOEM11/2	BOMBO EMB. BALERO 1 1/2"

Bombo embalado de aluminio y fierro colado.
Medidas de 1" hasta 1 1/2" y diámetro de 6".
USO: Cortinas metálicas exteriores.

APARATO PARA CORTINA



APCOCHDE	APARATO P/CORTINA CHICO DER.
APCOCHIZ	APARATO P/CORTINA CHICO IZQ.

Aparato de cadena reforzado para cortina metálica de acero, calibre placa de Acero 1/4", acabado pintado rojo óxido, con placa integrada.

Mecanismos con engranes para apertura y cerrado de cortinas metálicas de hasta de 5m de altura.

PASADOR DE CORTINA



PACO1	PASADOR DE CORTINA 1 RANURA
PACO1DO	PASADOR DE CORTINA 1 RANURA DOBLADO
PACO2	PASADOR DE CORTINA 2 RANURA
PACO2DO	PASADOR DE CORTINA 2 RANURA DOBLADO

REMACHES DE GOLPE



REGO 3	REMACHE DE GOLPE #3
REGO 4	REMACHE DE GOLPE #4

Remache de golpe galvanizado con cabeza plana hecho de acero suave para un fácil remachado.

PIEZA EUROPEA



PIEUGADER	PIEZA EUROPEA GALVANIZADA DERECHA
PIEEUGAIZQ	PIEZA EUROPEA GALVANIZADA IZQUIERDA

Pieza europea galvanizada que brinda gran sujeción a la tira de cortina.

PIEZA PLANA GALVANIZADA



PIEUPLDER	PIEZA PLANA GALVANIZADA DERECHA
PIEUPLIZQ	PIEZA PLANA GALVANIZADA IZQUIERDA

Pieza galvanizada plana que brinda gran sujeción a la tira de cortina plana.

ESLABÓN PARA CORTINA



ESLA01	ESLABÓN P/CORTINA #1
ESLA02	ESLABÓN P/CORTINA #2
ESLA03	ESLABÓN P/CORTINA #3

Eslabón de aluminio para cortina metálica en acabado natural, se utiliza para dar vista a las cortinas metálicas.

TARUGO PARA CORTINA



TARPCORT	TARUGO PARA CORTINA
----------	---------------------

Tarugo para cortina de acero fundido, sirve como accesorio para el aparato de cortinas.

ROSETA PARA CORTINA



ROSETA	ROSETA PARA CORTINA
--------	---------------------

Roseta para cortina de acero fundido que sirve como accesorio para el aparato de cortinas.

CARRILERA PARA CORTINA



CARRIL 014	CARRILERA C/14 (13.00)
CARRIL 016	CARRILERA C/16 (10.00)



LÍNEA DE CERRADURAS

Es muy importante saber determinar el abatimiento de tu puerta para comprar correctamente tu cerradura, este esquema te apoyará a hacerlo.

A) Colócate en la parte de afuera de la habitación y de frente a la puerta a la que colocarás la cerradura.

B) Observa de qué lado están colocadas las bisagras, si están del lado izquierdo solicita una cerradura para puerta izquierda y si están del lado derecho solicita una cerradura derecha.

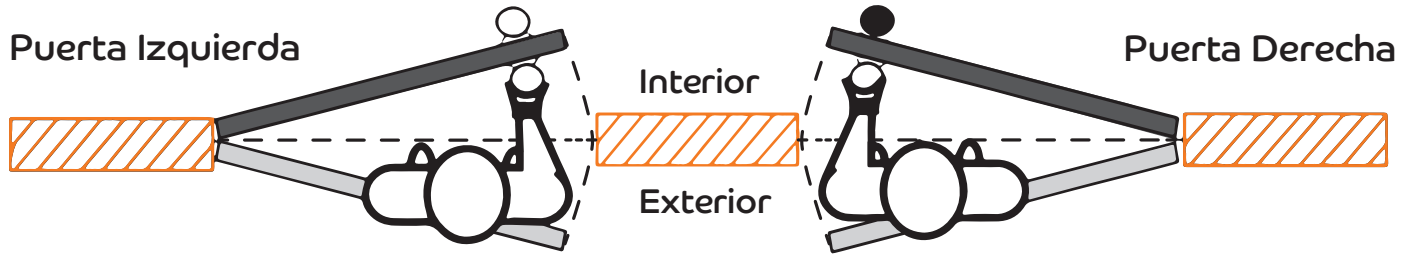

CERRADURA PHILLIPS 625

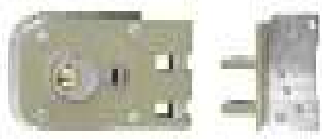

CHAP625IFD	CHAPA PHILLIPS 625 IF DER
CHAP625IFI	CHAPA PHILLIPS 625 IF IZQ
CHAP2536	CERRADURA 625 DERECHA
CHAP2537	CERRADURA 625 IZQUIERDA

Cerradura de sobreponer, el cerrojo se acciona con mariposa al interior, 5 pernos. Incluye placa metálica soldable. Cilindro ajustable hasta 2". Versión Clásica e Instalación fácil.
USO: Para puertas de abatir y corredizas.

CERRADURA PHILLIPS IF 715



CHAP715IFD	CHAPA PHILLIPS 715 IF DER
CHAP715IFI	CHAPA PHILLIPS 715 IF IZQ

Cerradura de sobreponer insta fácil con cilindro ensamblado para espesor de puerta de hasta 1.5", 5 pernos.
USO: Para puertas de madera o metálicas.

CERRADURA PHILLIPS 715



CHAP92	CERRADURA 715 CLÁSICA DERECHA
CHAP93	CERRADURA 715 CLÁSICA IZQUIERDA
CHAP5559	CERRADURA AS-715 DERECHA
CHAP5560	CERRADURA AS-715 IZQUIERDA

Cerradura de sobreponer clásica, con cilindro ajustable hasta 2" de espesor de puerta, 5 Pernos. Versión Clásica y alta seguridad.
USO: para puertas de madera o metálicas.

CERRADURA PHILLIPS 715LL



CHAP4656	CERRADURA 715 MC LL DERECHA
CHAP4657	CERRADURA 715 MC LL IZQUIERDA
CHAP4658	CERRADURA 715 MC IF LL DERECHA
CHAP4659	CERRADURA 715 MC IF IZQUIERDA

Cerradura de sobreponer con llave Larga, cilindro a 1,5" ya ensamblado, 5 Pernos. Mayor seguridad contra ganzúa. Versión clásica e insta fácil.
USO: para puertas de madera o metálicas.

CERRADURA PHILLIPS X720



CHAP1739	CERRADURA X720 DERECHA
CHAP1740	CERRADURA X720 IZQUIERDA
CHAP1741	CERRADURA X720 IF DERECHA
CHAP1742	CERRADURA X720 IF IZQUIERDA

Cerradura de sobreponer con llave Tetra de 9 pernos para una mayor seguridad contra ganzúa. Versión clásica e Insta fácil.
USO: Para puertas de madera o metálicas.

CERRADURA PHILLIPS AS-725



CHAP725D	CHAPA AS-725 DER
CHAP725I	CHAPA AS-725 IZQ

Cerradura de sobreponer con llave de puntos con 9 pernos para una mayor seguridad contra ganzúa.
USO: Para puertas de madera o metálicas.

CERRADURA PHILLIPS 740



CHAP94	CERRADURA 740 DERECHA/IZQUIERDA
CHAP5548	CERRADURA 740 AS DERECHA/IZQUIERDA

Cerradura de uso rudo con doble cerrojo de acero sólido de extra seguridad. Mecanismo de cremallera que se extienden en direcciones opuestas.
Llave larga de 5 pernos para mayor seguridad contra ganzúa. Versión Clásica y Alta seguridad.
USO: Para cortinas metálicas.

CERRADURA PHILLIPS 745



CHAPA 414	CERRADURA 745 DERECHA/IZQUIERDA
-----------	---------------------------------

Cerradura de uso rudo con cerrojo de acero sólido de extra seguridad. Llave larga de 5 pernos para mayor seguridad contra ganzúa.

USO: Para cortinas metálicas.

CERRADURA PHILLIPS X-750



CHAP574	CERRADURA X750 DERECHA /IZQUIERDA
---------	-----------------------------------

Cerradura de uso rudo con cerrojo de acero sólido de extra seguridad. Llave tetra de 6 pernos para mayor seguridad contra ganzúa.

USO: Para cortinas metálicas.

CERRADURA PHILLIPS 800



CHAP97	CERRADURA 800 FIJA DERECHA
CHAP98	CERRADURA 800 FIJA IZQUIERDA
CHAP99	CERRADURA 800 LIBRE DERECHA
CHAP100	CERRADURA 800 LIBRE IZQUIERDA

Cerrojo de acero sólido con carrera de 78mm. Versión mecanismo fijo y libre. Llave larga de 5 pernos para mayor seguridad contra ganzúa.

CERRADURA PHILLIPS X-900



CHAPX900D	CHAPA PHILLIPS X-900 IF DER
CHAPX900I	CHAPA PHILLIPS X-900 IF IZQ

Cerradura de barra de sobreponer con cerrojo de acero sólido de 78mm. Llave tetra de 6 pernos para mayor seguridad contra ganzúa.

CERRADURA PHILLIPS AS-2000



CHAP4685D	CERRADURA AS-2000 DERECHA BEIGE
CHAP4685I	CERRADURA AS-2000 IZQUIERDA BEIGE
CHAP4720D	CERRADURA AS-2000 DERECHA NEGRO
CHAP4720I	CERRADURA AS-2000 IZQUIERDA NEGRO

Cerradura de sobreponer de uso rudo, fácil inversión de picaporte con dos bulones de acero. Llave de puntos de 12 pernos. Cindro de 1.5" ya ensamblado.

CERRADURA PHILLIPS AS 3000



CHAP4686D	CERRADURA AS-3000 DERECHA BEIGE
CHAP4686I	CERRADURA AS-3000 IZQUIERDA BEIGE
CHAP4721D	CERRADURA AS-3000 DERECHA NEGRO
CHAP4721I	CERRADURA AS-3000 IZQUIERDA NEGRO

Cerradura de sobreponer de uso rudo, de alta seguridad con tres bulones de acero. Llave de puntos de 12 pernos. Cilindro de 1.5" ya ensamblado.

CERRADURA MORDAZA DEXTER 625



CHAD625D	CHAPA DEXTER MORDAZA 625 CLASICA DER (6758)
CHAD625I	CHAPA DEXTER MORDAZA 625 CLASICA IZQ (6759)

Cerradura Dexter de sobre poner mordaza, para puertas corredizas y de abatir.

CERRADURA DEXTER IF 751



CHA75IFD	CHAPA DEXTER INSTAFACIL DER (6760)
CHA75IFI	CHAPA DEXTER INSTAFACIL IZQ (6761)

Cerradura de sobreponer pre- armada T/715.

CERRADURA DEXTER DE BARRA LLAVE TETRA



CHAD6770	CERRADURA DE BARRA FIJA LLAVE TRAD. DERECHA
CHAD6771	CERRADURA DE BARRA FIJA LLAVE TRAD. IZQUIERDA

Cerradura Dexter de Barra de alta seguridad con llave tetra cromada.

CERRADURA DEXTER LLAVE TETRA



CHAP6785TETRDER	CHAPA DEXTER LLAVE TETRA DERECHA (6756)
CHAP6786TETRIZQ	CHAPA DEXTER LLAVE TETRA IZQ (6757)

Cerradura de sobreponer de alta seguridad llave tetra.

CERRADURA DEXTER BULONES 3 GIROS



CHAD5801	CERRADURA 3 BULONES DERECHA
CHAD5802	CERRADURA 3 BULONES IZQUIERDA

Cerradura de sobreponer con 3 bulones hexagonales de tres giros.



LÍNEA DE CANDADOS

CANDADO ANTI PALANCA



43355	CANDADO DE LATON, ANTIPALANCA, 50MM COR-50
43356	CANDADO DE LATON, ANTIPALANCA, 63MM COR-65
43357	CANDADO DE LATON, ANTIPALANCA, 76MM COR-75
43358	CANDADO DE LATON, ANTIPALANCA, 88MM COR-88

Candado anti palanca de varios tamaños, cuerpo de latón sólido. Seguro de balín, para cortina metálica. Incluyen 2 llaves.

CANDADO CON CORAZA



43312	CANDADO DE HIERRO CON CORAZA, 40MM, LLAVE ABLOY CHR-40 ^a
43313	CANDADO DE HIERRO CON CORAZA, 50MM, LLAVE ABLOY CHR-50 ^a
43314	CANDADO DE HIERRO CON CORAZA, 60MM, LLAVE ABLOY CHR-60 ^a

Candado de hierro con coraza, llave anti-ganzúa de acero. Cilindro de latón sólido. Incluye 3 llaves.

CANDADO ANTI PALANCA CUBIERTO



CAN-16934	CANDADO ANTI PALANCA CUBIERTO 70MM AZUL
CAN-16935	CANDADO ANTI PALANCA CUBIERTO 70MM ROJO

Candado Anti palanca cubierto con cilindro de latón. Alta resistencia al corte, resistente a la intemperie. Ideal para cortinas metálicas.

CANDADO MULTIUSOS DE COMBINACIÓN



CAN-6318	CANDADO MULTIUSOS COMBINACIÓN
----------	-------------------------------

Candado de 36mm multiusos de combinación, en donde la apertura es por medio de un botón de seguridad.

CANDADO ANTI PALANCA LLAVE TETRA



CAN-16932	CANDADO ANTI PALANCA LLAVE TETRA
-----------	----------------------------------

Candado Anti palanca de llave Tetra, cilindro de latón, con alta resistencia al corte. Ideal para cortinas metálicas.

CANDADO DE SEGURIDAD



CAN6943	CANDADO DE SEGURIDAD GANCHO CORTO
CAN6944	CANDADO DE SEGURIDAD GANCHO LARGO

Candado de seguridad de 62 mm gancho corto y largo, con alta resistencia al impacto y al cote, con doble cerrojo tipo balín.

CANDADO COMBINACIÓN DE DISCOS



CAN6963	CANDADO COMB. DISCOS DE ACERO 30MM
CAN6964	CANDADO COMB. DISCOS DE ACERO 40MM

Candado en combinación de discos con gancho corto con alta resistencia al corte, llave anti ganzúa y doble cerrojo tipo balín.

CANDADO GANCHO CORTO



43318	CANDADO DE HIERRO, 38MM CHB-38
43319	CANDADO DE HIERRO, 45MM CHB-45
43320	CANDADO DE HIERRO, 50MM CHB-50
43792	CANDADO DE HIERRO 32MM GANCHO STD, BLISTER CHB-32
43796	CANDADO DE HIERRO, BLISTER, 25MM CHB-25

Candado de hierro, gancho corto con cilindro de latón sólido, seguro tipo perno. Incluye 2 llaves.

CANDADO DE HIERRO



23523	CANDADO DE HIERRO, 30 MM, BLISTER, HERMEX BASIC CHB-30P
22527	CANDADO DE HIERRO, 20 MM, BLISTER, HERMEX BASIC CHB-20P
22529	CANDADO DE HIERRO, 25 MM, BLISTER, HERMEX BASIC CHB-25P

Candado de hierro color latón, gancho corto. Cilindro metálico, seguro tipo perno. Incluyen 2 llaves.

CANDADO GANCHO LARGO



43326	CANDADO DE HIERRO, 38MM, GANCHO LARGO CHB-38L
43327	CANDADO DE HIERRO, 45MM, GANCHO LARGO CHB-45L
43328	CANDADO DE HIERRO, 50MM, GANCHO LARGO CHB-50L
43798	CANDADO DE HIERRO, BLISTER, 25MM, LARGO CHB-25L
43794	CANDADO DE HIERRO 32MM GANCHO LARGO BLISTER CHB-32L

Candado de hierro, gancho largo, cilindro de latón sólido. Tiene seguro tipo perno. Incluyen 2 llaves.



**LÍNEA DE
HERRAJES
DECORATIVOS**

Estos herrajes son ideales para decorar y embellecer tanto la fachada como las áreas internas de cualquier inmueble. Se pueden aplicar en balcones, rejas, barandales, protecciones para ventanas y puertas, escaleras, etc... Podrás encontrar una gran cantidad de figuras artísticas hechas de acero y hierro colado, resistentes a cualquier ambiente y de larga duración con diseños vanguardistas y coloniales.

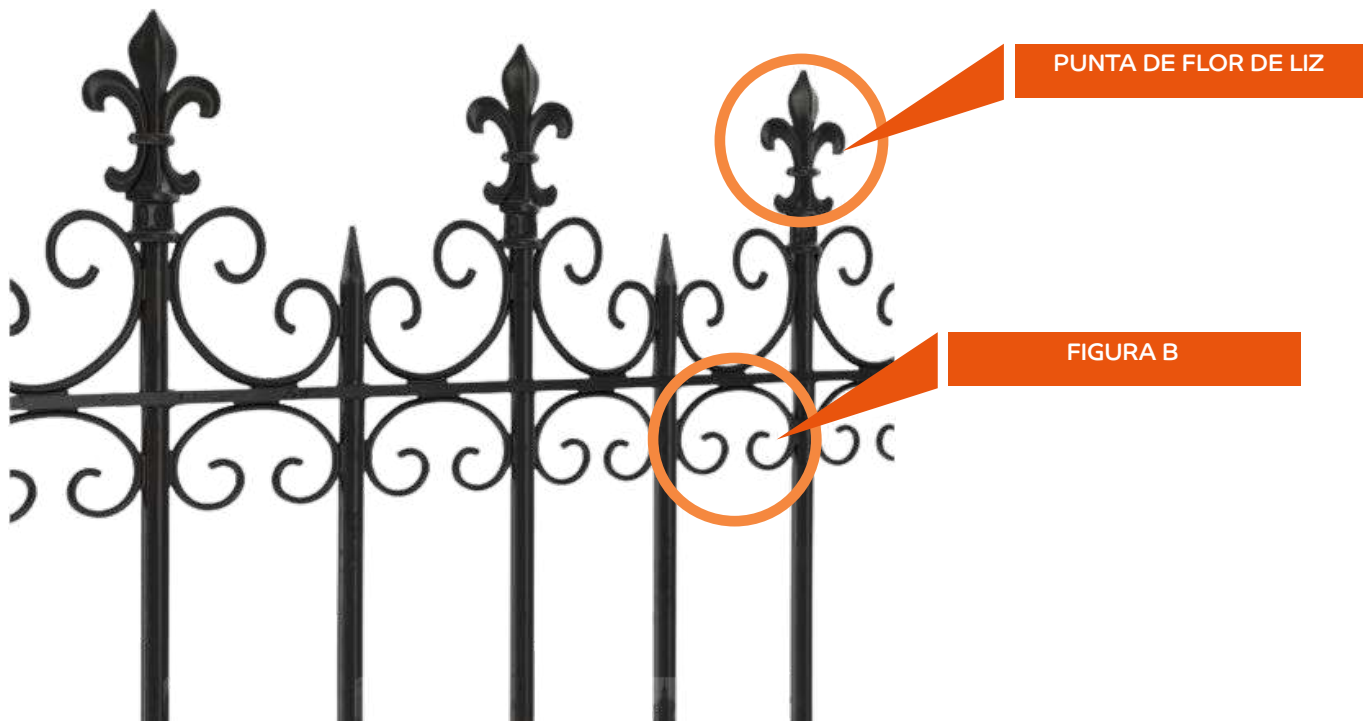

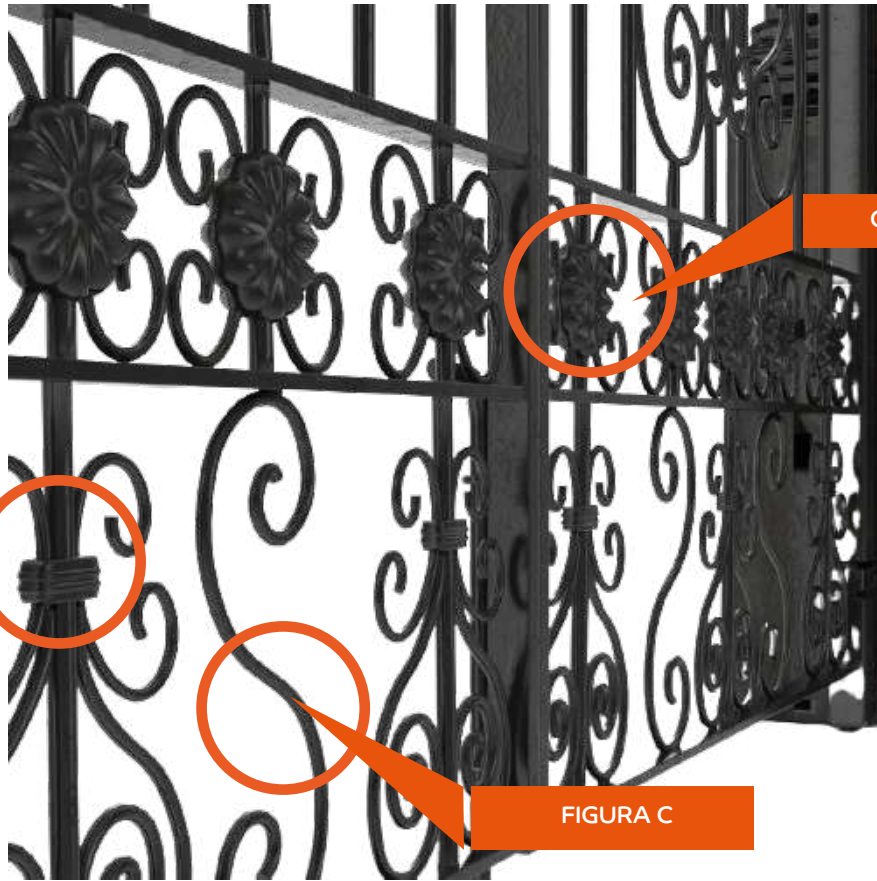

CHAPETÓN CHICO

NUDO DE CRUZ

FIGURA C

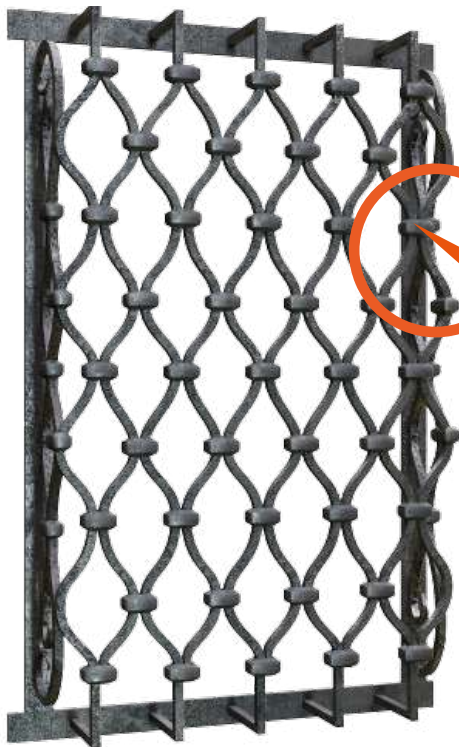

NUDOS FORJADOS

Figuras de Forja artística elaborada de solera soldable sin pintar. Ideales para la decoración y protección de puertas, ventanas, zaguanes, barandales y balcones.

FORJA ARO



REFOAR12	FORJA ARO DE 12 CM
REFOAR14	FORJA ARO DE 14 CM
REFOAR16	FORJA ARO DE 16 CM

FIGURA A



*Sugerencia de uso

FFA20	FIGURA A 20 x 8 CMS
-------	---------------------

FIGURA A1



*Sugerencia de uso

FFA-20	FIGURA A1 20 x 8 CMS
--------	----------------------

FIGURA B



*Sugerencia de uso

FFBA16	FIGURA B 16 X 8 CMS
--------	---------------------

FIGURA C



*Sugerencia de uso

FFA23.5	FIGURA C 23.5 x 8.0 CMS
---------	-------------------------

FIGURA CC



*Sugerencia de uso

FFA33.5	FIGURA CC 33.5 x 12 CMS
---------	-------------------------

FIGURA C3 Y C4



FFA12	FIGURA C3 12 CMS DIÁMETRO
FFA16	FIGURA C4 16 CMS DIÁMETRO

FIGURA R



*Sugerencia de uso

FFA60	FIGURA R 60X8
FFA43	FIGURA R1 43X8

FIGURA U



FFA58.5	FIGURA U 58.5X8
FFA31	FIGURA U1 31 x 8 CMS



*Sugerencia de uso

FIGURA V



FFA-33	FIGURA V 59 x 8 CMS
FFA33	FIGURA V1 33 x 8 CMS



*Sugerencia de uso

FIGURA X



FFA-34	FIGURA X 59.8 x 39.8 CMS
FFA34	FIGURA X1 34 x 8 CMS



*Sugerencia de uso

BIGOTE DE SOLERA



BI13X8	BIGOTE DE 13X8
BI9X9	BIGOTE DE 9 X 9

PIÑA 01



PIÑA01	PIÑA DE 1/2 15X8 CM
--------	------------------------

PIÑA 02



PIÑA02	PIÑA DE 2 1/2 12X6.5 CM
--------	----------------------------

PIÑA 03



PIÑA03	PIÑA DE 3 1/2 12X5 CM
--------	--------------------------

PIÑA 04



PIÑA04	PIÑA DE 1/2 15X16 CM
--------	-------------------------

PIÑA 05



PIÑA05	PIÑA DE 5/8 15X7.5 CM
--------	--------------------------

PIÑA 06



PIÑA06	PIÑA DE 5/8 15X6 CM
--------	------------------------

PIÑA 07



PIÑA07	PIÑA DE 5/8 15X6.5 CM
--------	--------------------------

PIÑA 08



PIÑA08	PIÑA DE 1/2 8.2X4 CM
--------	-------------------------

PIÑA 09



PIÑA09	PIÑA DE 1/2 33X8 CM
--------	------------------------

PIÑA 010



PIÑA010	PIÑA DE 1/2 28X6 CM
---------	------------------------

PIÑA 011



PIÑA011	PIÑA DE 3/4 33X8 CM
---------	------------------------

PIÑA 012



PIÑA012	PIÑA DE 3/4 27X8 CM
---------	------------------------

PIÑA 013



PIÑA013	PIÑA DE 1/2 16.5X8.7 CM
---------	----------------------------

ARO REDONDO



AR10RE1/2	ARO 10CM DE REDONDO 1/2"
AR10RE5/8	ARO 10CM DE REDONDO 5/8"
AR11RE1/2	ARO 11CM DE REDONDO 1/2"
AR12RE1/2	ARO 12CM DE REDONDO 1/2"
AR12RE5/8	ARO 12CM DE REDONDO 5/8"
AR14RE1/2	ARO 14CM DE REDONDO 1/2"
AR14RE5/8	ARO 14CM DE REDONDO 5/8"
AR15RE1/2	ARO 15CM DE REDONDO 1/2"
AR15RE5/8	ARO 15CM DE REDONDO 5/8"
AR16RE1/2	ARO 16CM DE REDONDO 1/2"
AR20RE1/2	ARO 20CM DE REDONDO 1/2"
AR20RE5/8	ARO 20CM DE REDONDO 5/8"
AR25RE1	ARO 25CM DE REDONDO 1"
AR25RE3/4	ARO 25CM DE REDONDO 3/4"

ARO EN CUADRADO



AR10CU1/2	ARO 10CM DE CUADRADO 1/2"
AR12CU1/2	ARO 12CM DE CUADRADO 1/2"
AR12CU5/8	ARO 12CM DE CUADRADO 5/8"
AR14CU1/2	ARO 14CM DE CUADRADO 1/2"
AR16CU1/2	ARO 16CM DE CUADRADO 1/2"
AR16CU5/8	ARO 16CM DE CUADRADO 5/8"
AR20CU1/2	ARO 20CM DE CUADRADO 1/2"

PUNTAS Y NUDOS

PUNTA



PUN02

PUNTA AZTECA C-1/2
(245A)

PUNTA



P5509

PUNTA BARROCO C-1/2
(277)

PUNTA



PUN09

PUNTA FLOR DE LIZ S/
PROTECCIÓN C-1/2 (261)

PUNTA



PUN13

PUNTA FLOR DE LIZ CON
PROTECCIÓN C-1/2 (260)

PUNTA



PUN06

PUNTA GÓTICO C-1/2
(215)

PUNTA



PUN03

PUNTA ROMANA C-1/2
Chica

PUN03G

PUNTA ROMANA C-1/2
Grande

PUNTA



P5507

PUNTA
CONTEMPORANEO C/
PROTECCIÓN C-1/2 (217B)

PUNTA



PUN01

PUNTA SAMURAI C-1/2
(224)

PUNTA



P5508

PUNTA GALO C-1/2 (218)

NUDO AZTECA



CUELLO

CUELLO AZTECA C-1/2
(245)

NUDO



NU1/2FO

NUDO DE 1/2" FORJADO

NU5/8FO

NUDO DE 5/8" FORJADO

CUELLO



CUELLO10

CUELLO FOFO
P/REDONDO 5/8"(242)

CUELLO09

CUELLO FOFO
REDONDO 1/2" (242)

Todas las puntas, nudos y lanzas son para decoración metálica.

CUELLO NAPOLITANO



CUELLO011	CUELLO NAPOLITANO CUADRADO 1/2" (256)
CUELLO06	CUELLO NAPOLITANO CUADRADO 5/8" (256)
CUELLO05	CUELLO NAPOLITANO RED. 1/2" (256)
CUELLO07	CUELLO NAPOLITANO REDONDO 5/8" (256)

PUNTAS Y NUDOS

MEDIO CUELLO



CUELLO03	MEDIO CUELLO PARA CUADRADO 1/2" HOR (251H)
----------	--

NUDO FOFO



NU1/2FOFO	NUDO DE 1/2" FO.FO. (251)
NUFI3/4CU	NUDO FO.FO. 3/4" CUADRADO (251)
NUFI5/8CU	NUDO FO.FO.5/8" CUADRADO (251)

NUDO



FAAC0444	NUDO ESPAÑOL P/CUADRADO 1/2" 4.5
----------	----------------------------------

CUELLO BOTELLA



CUELLO08	CUELLO BOTELLA RED. 1/2"
----------	--------------------------

REMATE FRANCES



REMATEFRAN01	REMATE FRANCÉS PARA CUADRADO 1/2"
REMATEFRAN03	REMATE FRANCÉS PARA REDONDO 5/8"
REMATEFRAN02	REMATE FRANCÉS PARA REDONDO 1/2"

REMATE FRANCES DOBLE



P5519	REMATE FRANCES DOBLE REDONDO 1/2"
-------	-----------------------------------

NUDO



NUCR1/2	NUDO DE CRUZ DE 1/2"
---------	----------------------

TAPA POSTE



TAPABOL1	TAPA POSTE CON BOLA 1"
TAPABOL11/4	TAPA POSTE CON BOLA 1 1/4"
TAPABOL11/2	TAPA POSTE CON BOLA 1 1/2"
TAPABOL2	TAPA POSTE CON BOLA 2"

PUNTAS Y NUDOS

Puntas de fierro forjado de protección de material fierro negro cuadrado en acabado natural.

PUNTA FORJADA



PUFO1/2	PUNTA FORJADA C - 1/2" 130 x 13mm
PUFO3/8	PUNTA FORJADA DE 3/8" 137 x 10mm

PUNTA FORJADA CURVA



PUFOCU1/2	PUNTA FORJA CURVA C-1/2" 80 x 13 mm
PUFOCU3/8	PUNTA FORJA CURVA 3/8" 76 x 10 mm

PUNTA FORJADA MAGUEY



PUFOMA1/2	PUNTA FORJA MAGUEY C- 1/2" 140 x 200 mm
PUFOMA3/8	PUNTA FORJA MAGUEY 3/8" 132 x 195 mm

PUNTA FORJADA LANZA TORCIDA



PUFOLA1/2TO	PUNTA FORJA LANZA 1/2" TORCIDA
PUFO3/8TO	PUNTA FORJADA TORCIDA DE 3/8"

PUNTA FORJADA LANZA



PUFOLA1/2	PUNTA FORJA LANZA 1/2" (RH) 130 x 150 mm
PUFOLA3/8	PUNTA FORJA LANZA 3/8" 130 x 40 mm
PUFOLA5/8	PUNTA FORJA LANZA 5/8" 160 x 55mm
PUFOLA3/4	PUNTA FORJADA LANZA 3/4" 170 x 68mm

SUPER PICOS

SUPER05



SUPER05 SUPER PICO NO 05 (FORJA)

SUPER08



SUPER08 SUPER PICO NO 08 (FORJA)

SUPER09



SUPER01 SUPER PICO NO 09 (FORJA)

SUPER 10



SUPER02 SUPER PICO NO 10 (FORJA)

SUPER 14



SUPER14 SUPER PICO NO 14 (FORJA)

FORJA ANTIGUA

Son figuras fabricadas con acero, para que sus protecciones y barandales luzcan bien a parte de proteger su hogar o negocio.

C-1



FAC-1 FORJA ANTIGUA C-1 21 x 12 cm

C-2



FAC-2 FORJA ANTIGUA C-2 16 x 21 cm

C-3



FAC-3 FORJA ANTIGUA C-3 12 cm

C-4



FAC-4 FORJA ANTIGUA C-4 16 cm

C-5



FAC-5 FORJA ANTIGUA C-5 17.5 x 16 cm

C-6



FAC-6 FORJA ANTIGUA C-6 17 x 16 cm

FORJA ANTIGUA

C-7



FAC-7	FORJA ANTIGUA C-7 36 x 12 cm
--------------	---------------------------------

C-8



FAC-8	FORJA ANTIGUA V C-8 33 x 12 cm
--------------	-----------------------------------

C-9



FAC-9	FORJA ANTIGUA C-9 61.5 x 12 cm
--------------	-----------------------------------

C-10



C-10	FAC-10 FORJA ANTIGUA C-10 61.5 x 12 cm
-------------	---

C-11



FAC-11	FORJA ANTIGUA C-11 61.5 x 12 cm
---------------	------------------------------------

C-12



FAC-12	FORJA ANTIGUA C-12 49.5 x 14.7 cm
---------------	--------------------------------------

C-13



FAC-13	FORJA ANTIGUA C-13 33 x 12 cm
---------------	----------------------------------

C-14



FAC-14	FORJA ANTIGUA C-14 32 x 12 cm
---------------	----------------------------------

C-15



FAC-15	FORJA ANTIGUA C-15 28 x 12 cm
---------------	----------------------------------

C-16



C-16	FAC-16 FORJA ANTIGUA C-16 37 x 10 cm
-------------	---

C-17



C-17	FAC-17 FORJA ANTIGUA C-17 16 x 12 cm
-------------	---

C-18



FAC-18	FORJA ANTIGUA C-18 14 cm
---------------	-----------------------------

FORJA BARROCA

B-1



FBB-1 FORJA BARROCO SOLIDO
B-1 17 x 12 cm

B-2



FBB-2 FORJA BARROCO SOLIDO
B-2 21 x 14 cm

B-3



FBB-3 FORJA BARROCO
SOLIDO B-3 16 x 12 cm

B-4



FBB-4 FORJA BARROCO SOLIDO
B-4 16 x 12 cm

B-5



FBB-5 FORJA BARROCO SOLIDO
B-5 39 x 21 cm

B-6



FBB-6 FORJA BARROCO
SOLIDO B-6 39 x 22.5 cm

B-7



FBB-7 FORJA BARROCO SOLIDO B-7
45 x 15 cm

B-8



FBB-8 FORJA BARROCO SOLIDO
B-8 28 x 17 cm

C1-M



FAMC-1 FORJA ANTIGUA
MARTILLADA
C-1 16 x 12 cm

C2-M



FAMC-2 FORJA ANTIGUA
MARTILLADA
C-2 21 x 12 cm

C3-M



FAMC-3 FORJA ANTIGUA
MARTILLADA
C-3 12 cm

C4-M



FAMC-4 FORJA ANTIGUA
MARTILLADA
C-4 16 cm

FORJA BARROCA

C5-M



FAMC-5	FORJA ANTIGUA MARTILLADA C-5 17.5 x 12 cm
---------------	---

C6-M



FAMC-6	FORJA ANTIGUA MARTILLADA C-6 17 x 16 cm
---------------	---

C7-M



FAMC-7	FORJA ANTIGUA MARTILLADA C-7 36 x 12 cm
---------------	---

C8-M



FAMC-8	FORJA ANTIGUA MARTILLADA C-8 33 x 12 cm
---------------	---

C9-M



FAMC-9	FORJA ANTIGUA MARTILLADA C-9 61.5 x 12 cm
---------------	---

C10-M



FAMC-10	FORJA ANTIGUA MARTILLADA C-10 61.5 x 12 cm
----------------	--

C11-M



FAMC-11	FORJA ANTIGUA MARTILLADA C-11 61.5 x 12 cm
----------------	--

C12-M



FAMC-12	FORJA ANTIGUA MARTILLADA C-12 49.5 x 14.7 cm
----------------	--

C13-M



FAMC-13	FORJA ANTIGUA MARTILLADA C-13 33 x 12 cm
----------------	--

FORJA BARROCA

C14-M



FAMC-14

FORJA ANTIGUA
MARTILLADA
C-14 17.5 x 12 cm

C15-M



FAMC-15

FORJA ANTIGUA
MARTILLADA
C-15 28 x 12 cm

C16-M



FAMC-16

FORJA ANTIGUA
MARTILLADA
C-16 36 x 12 cm

C17-M



FAMC-17

FORJA ANTIGUA
MARTILLADA C-17 33 x 12 cm

C18-M



FAMC-18

FORJA ANTIGUA
MARTILLADA C-18 14 cm

ADORNOS TROQUELADOS

Adornos decorativos troquelados fabricados en lámina de acero.

CHAPETÓN CHICO



CHCH CHAPETÓN CHICO

Medida Ø 67 cal.14

CHAPETÓN CHICO CON REMACHE SUELTO



CHAPE011 CHAPETÓN CHICO CON REMACHE SUELTO

Medida Ø 67 cal.14

CHAPETÓN GRANDE



CHGR CHAPETÓN GRANDE

Medida Ø 100 cal.16

CHAPETÓN GRANDE CON REMACHE SUELTO



CHAPE012 CHAPETÓN GRANDE CON REMACHE SUELTO

Medida Ø 100

CHAPETÓN DOBLE



CHDO CHAPETÓN DOBLE

Medida Ø100

CHAPETÓN ESTRELLA



CHAPE006 CHAPETÓN ESTRELLA

Medida Ø 90

CHAPETÓN ESTRELLA CON REMACHE



CHESR CHAPETÓN ESTRELLA CON REMACHE

Medida Ø 90

CHAPETÓN SOL



CHAPE017 CHAPETÓN SOL NO.2

CHAPE018 CHAPETÓN SOL NO.3

Medida Ø 67 cal.14

CHAPETÓN MARGARITA



CHAPE009 CHAPETÓN MINI MARGARITA

Medida diámetro 4 cm

ADORNOS TROQUELADOS

CHAPETÓN PERFORADO

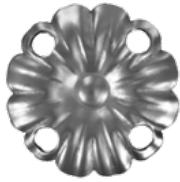

CHAPE004	CHAPETÓN GRANDE 4 PERF C/REMACHE SUELTO
----------	---

Medida diámetro 5 5/8"

MAGNOLIA



FLOR06	MAGNOLIA
--------	----------

Medida Ø 6 1/2"

BOTÓN DE ROSA



BOROSA01	BOTÓN DE ROSA C20
----------	-------------------

Medida 45 x 40 mm

ROSA

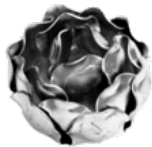

FLOR01	ROSA
--------	------

Medida 35 x 70 mm

JARRÓN



JARR008	JARRON CHICO
JARR002	JARRON GRANDE

Medida Ch. 115 x 245 mm
Gde. 164 x 350 mm

ARO AZTECA



ARO ZT01	ARO AZTECA CHICO (CARACOL)
----------	----------------------------

Medida 12 y 16 cm

CHAPETÓN MEDIA ESFERA MARTILLADO



CHMEES1MA	CHAPETÓN MEDIA ESFERA 1" MARTILLADO
CHMEES11/4MA	CHAPETÓN MEDIA ESFERA MARTILLADO 1 1/4"
CHMEES11/2MA	CHAPETÓN MEDIA ESFERA MARTILLADO 1 1/2"
CHMEES2MA	CHAPETÓN MEDIA ESFERA 2" MARTILLADO

CHAPETÓN MEDIA ESFERA



CHMEES1	CHAPETÓN MEDIA ESFERA 1"
CHMEES1/2	CHAPETÓN MEDIA ESFERA 1/2"
CHMEES11/2	CHAPETÓN MEDIA ESFERA 1 1/2"
CHMEES21/2	CHAPETÓN MEDIA ESFERA 2 1/2"
CHMEES3	CHAPETÓN MEDIA ESFERA 3"
CHMEES4	CHAPETÓN MEDIA ESFERA 4"

ESFERA CIEGA



ESFC1	ESFERA CIEGA DE 1"
ESFC11/2	ESFERA CIEGA DE 1 1/2"
ESFC2	ESFERA CIEGA DE 2"
ESFC21/2	ESFERA CIEGA DE 2 1/2"
ESFC3	ESFERA CIEGA DE 3"
ESFC4	ESFERA CIEGA DE 4"

ADORNOS TROQUELADOS

ESFERA DE UNA PERFORACIÓN



ESF1	ESFERA DE 1" UNA PERFORACIÓN
ESF11/2	ESFERA DE 1 ½" UNA PERFORACIÓN
ESF2	ESFERA DE 2" UNA PERFORACIÓN
ESF3	ESFERA DE 3" UNA PERFORACIÓN

ESFERA DOBLE PERFORACIÓN



ESF11/2D	ESFERA DE 1 ½" DOBLE PERFORACIÓN
ESF2D	ESFERA DE 2" DOBLE PERFORACIÓN
ESF3D	ESFERA DE 3" DOBLE PERFORACIÓN
ESF4D	ESFERA DE 4" DOBLE PERFORACIÓN

CONSTELACIÓN



CONSTELACION005	CONSTELACIÓN CHICA (FORJA) 324mm
CONSTELACION006	CONSTELACIÓN GRANDE (FORJA) 560 mm

MANZANA



MANZA01	MANZANA
---------	---------

Medida Ø 6 cm

VÍRGEN DE GUADALUPE



VIRGEN01	VÍRGEN LÁMINA
----------	---------------

Medida 365 x 222 mm

ECLIPSE



ECLIPSECH	ECLIPSE CHICO 159 x 132 mm
ECLIPSE	ECLIPSE GRANDE 400mm

SOL DE LÁMINA



SOL	SOL DE LÁMINA
-----	---------------

Medida Ø 128 mm

SOL GRANDE DE LÁMINA



SOL003	SOL GRANDE
--------	------------

HOJA ALA DE CISNE



HOJA003	HOJA ALA DE CISNE
---------	-------------------

Medida 94 x 98 mm

ADORNOS TROQUELADOS

HOJA ALA DE QUERUBÍN



HOJA004D	ALA DE QUERUBÍN (DER)
HOJA004I	ALA DE QUERUBÍN (IZQ)

Medida 120 x 90mm

HOJA ALA DE SERAFÍN



HOJA005	ALA DE SERAFÍN
---------	----------------

Medida 185 x 80 mm

ALA DE ÁNGEL



HOJA001	HOJA ALA DE ANGEL DERECHA
HOJA002	HOJA ALA DE ANGEL IZQUIERDA

Medida 119 x 42 mm

HOJA DE RETOÑO



HOJA24	RETOÑO DERECHO
HOJA25	RETOÑO IZQUIERDO

Medida 95 x 60 mm

TULIPÁN



FLOR05	TULIPÁN ABIERTO
FLOR08	TULIPÁN CERRADO

Medida abierto 84 x 70 mm
Cerrado 67 x 58 mm

ESTRELLA DE LÁMINA



ESTRELLA01	ESTRELLA DE LÁMINA CHICA
ESLAGR	ESTRELLA GRANDE 40 CM
ESLAME	ESTRELLA MEDIANA 20 cm
ESLAMI	ESTRELLA DE LÁMINA MINI

FLOR CACTUS



FLOR10	FLOR CACTUS
--------	-------------

Medida Ø 40 mm

SOMBRERO



SOMBRE01	SOMBRERO LÁMINA
----------	-----------------

Medida 120 x 60 mm

TORO DE LÁMINA



TORO01	TORO DE LÁMINA
--------	----------------

Medida 120 x 95 mm

ANIMALES DECORATIVOS

COTORRO



COTORR01	COTORRO DERECHO
COTORR02	COTORRO IZQUIERDO

Medida 200 x 64 mm

GOLONDRINA



GOLDER	GOLONDRINA DERECHA
GOLDIZQ	GOLONDRINA IZQUIERDA

Medida 160 x 110 mm

LOBO



LOBO01	LOBO LAMINA C20
--------	-----------------

Medida 125 x 100 mm

MARIPOSA



MARIO1	MARIPOSA DE DECORACIÓN
--------	------------------------

Medida 105 x 95 mm

NIDO



NIDO01	NIDO C20
--------	----------

Medida 120 x 119 mm

TUCÁN



TUCAN01	TUCÁN LÁMINA
---------	--------------

Medida 300 x 150 mm

PLATO PORTAVELA



PLPO1 1/2	PLATO PORTA VELA DE 1 ½ "
PLPO2	PLATO PORTA VELA DE 2"
PLPO2 1/2	PLATO PORTA VELA DE 2 ½ "
PLPO3	PLATO PORTA VELA DE 3"
PLPO3 1/2	PLATO PORTA VELA DE 3 ½ "
PLPO4	PLATO PORTA VELA DE 4"
PLPO4 1/2	PLATO PORTA VELA DE 4 ½ "
PLPO5	PLATO PORTA VELA DE 5"
PLPO6	PLATO PORTA VELA DE 6"
PLPO8	PLATO PORTA VELA DE 8"
PLPO10	PLATO PORTA VELA DE 10"

REMACHE PARA CHAPETÓN



RECHA	REMACHE PARA CHAPETÓN
-------	-----------------------

GRAPA



GRAPA	
GR1 /2	GRAPA DE 1/2" 1 COSTILLA
GR1	GRAPA DE 1" 1 COSTILLA
GR11/2	GRAPA DE 1 1/2" 1 COSTILLA
GR1/22C	GRAPA DE 1/2" 2 COSTILLAS
GR12C	GRAPA DE 1" 2 COSTILLAS
GR11/22C	GRAPA DE 1 1/2" 2 COSTILLAS

HOJAS DECORATIVAS

HOJA BANDERA



HOJA007	HOJA BANDERA
---------	--------------

Medida 140 x 180 mm

HOJA DE HIGO



HOJA15	HOJA DE HIGO DER
HOJA16	HOJA DE HIGO IZQ

Medida 62 x 70 mm

HOJA DE HIGUERA



HOJA17	HOJA DE HIGUERA
--------	-----------------

Medida 190 x 195 mm

HOJA DE GIRASOL



HOGI	HOJA DE GIRASOL
------	-----------------

Medida 100 x 75mm

HOJA DE FRESNO



HOJA12	HOJA DE FRESNO
--------	----------------

Medida 70 x 48 mm

HOJA DE LIMÓN



HOJA19	HOJA DE LIMÓN
--------	---------------

Medida 101 x 30mm

HOJA DE OLIVA



HOJA22	HOJA DE OLIVA
--------	---------------

Medida 36 x 100 mm

HOJA DE ROSA



HOJA26	HOJA DE ROSA
HOROG	HOJA DE ROSA GRANDE

Medida ch. 60 x 30 mm
Medida gde. 80 x 40 mm

HOJA DE ROSA DISEÑO



HORODI	HOJA DE ROSA DISEÑO
--------	---------------------

Medida 80 x 45 mm

HOJA DE MAPLE



HOJA21	HOJA DE MAPLE
--------	---------------

Medida 75 x 75 mm

HOJA JULIETA



HOJA18	HOJA JULIETA
--------	--------------

Medida 102 x 143 mm

HOJA DE AMAPOLA



HOJA006	HOJA DE AMAPOLA
---------	-----------------

Medida 122 x 62 mm

HOJAS DECORATIVAS

HOJA DE DURAZNO



HOJA10 HOJA DE DURAZNO

Medida 68 x 17 mm

HOJA DE BUGAMBILIA



HOJABUG HOJA DE BUGAMBILIA

Medida 98 x 47 mm

HOJA DE EUCALIPTO



HOJA31 HOJA DE EUCALIPTO

Medida 72 x 30mm

HOJA DE HELECHO



HOJA13 HOJA DE HELECHO

Medida 100 x 238 mm

HOJA DE HIEDRA



HOJA14 HOJA DE HIEDRA

Medida 80 x 65 mm

HOJA BARROCO



HOJA008 HOJA BARROCO CHICA

HOJA009 HOJA BARROCO GRANDE

Medida ch 64 x 90 mm
Medida gde 90 x 300 mm

HOJA DE GERANIO



HOJA28 HOJA GERANIO

Medida 140 x 16 mm

HOJA DE VIÑA



HOJA34 HOJA VIÑA (FORJADA)

Medida 65 x 80 mm

ROSETONES

ROSETÓN



RESET04 ROSETÓN DE 22.5 CM(002)

CORINTIO

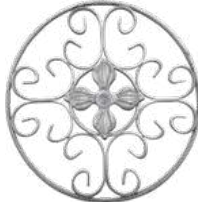

RESET06 ROSETÓN CORINTIO
33.5 CM

COTORRO



RESET07 ROSETÓN COTORRO
33.5 CM

ESTRELLA

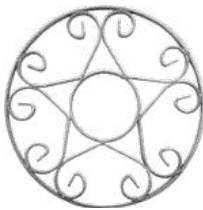

RESET10 ROSETÓN ESTRELLA
33.5 CM

FORTUNA

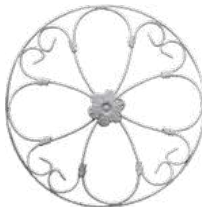

RESET11 ROSETÓN FORTUNA
33.5 CM

SOL CHICO

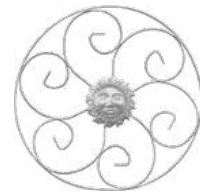

RESET14 ROSETÓN SOL
PEQUEÑO

PÁJARO



RESET12 ROSETÓN PAJARO
33.5 CM

ROSETÓN NO.1



RESE01 ROSETÓN NO.1
25.01 CM

PANTALLA ARTÍSTICA

Las Pantallas artísticas le permite embellecer la fachada de su hogar, negocio o proyecto arquitectónico, al mismo tiempo que resguarda su privacidad. Fabricados en Lámina de Acero al Carbón Calibre 14 . Medidas 61 x 1.22 m y 1.22 x 2.44 m



MODELO 1

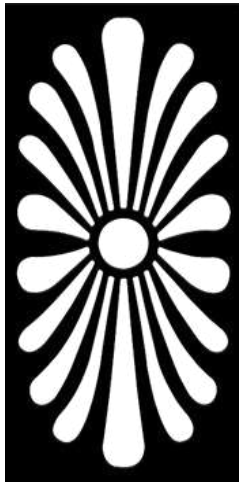

MODELO 2



MODELO 3

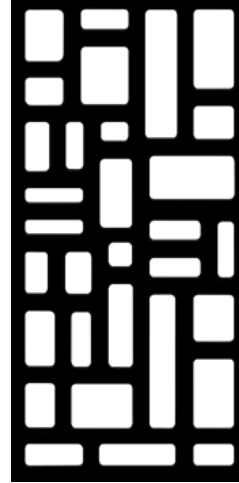

MODELO 4

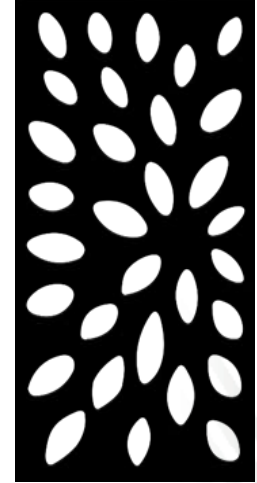

MODELO 5

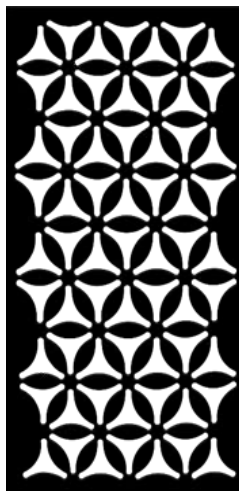

MODELO 6

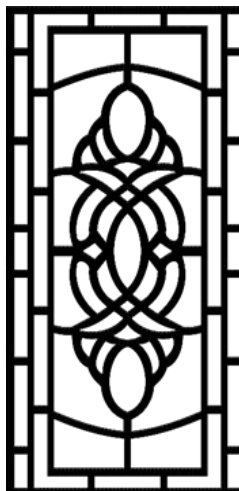

MODELO 7



MODELO 8

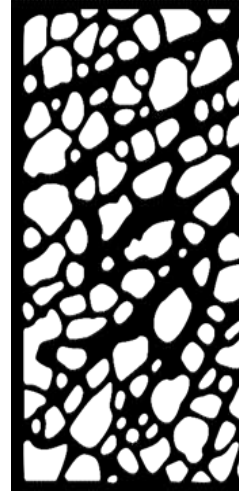

MODELO 9

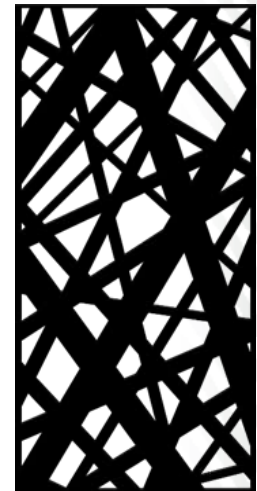

MODELO 10

SOBRE PEDIDO



LÍNEA DE ESMALTES Y ACCESORIOS

PINTURAS Y ACCESORIOS

Ya sea que necesites redecorar tu espacio, o darle vida a un proyecto más grande, tenemos artículos para llevar a cabo todos tus planes.

PINTURA (MARCA PINTOLUX)



ACABADO: * ESMALTE * VINÍLICA
PRESENTACIÓN: Litro, Galón, cubeta 19l
USO: Recomendado en interiores y exteriores de metal, estructuras metálicas. *Estos colores son aproximados a los reales.



ESM5E-1000BL-1L	ESMALTE BLANCO 1000 1LT
ESM5E-1000BL-4L	ESMALTE BLANCO 1000 GAL
ESM5E-1000BL-19L	ESMALTE BLANCO 1000 19LT
ESM5EP-1500BL-1L	ESMALTE BLANCO PLUS 1500 1 LT
ESM5EP-1500BL-4L	ESMALTE BLANCO PLUS 1500 GAL
ESM5EP-1500BL-19L	ESMALTE BLANCO PLUS 1500 19 LT



ESM5E-1013GR-1L	ESMALTE GRIS ACERO 1013 1LT
ESM5E-1013GR-4L	ESMALTE GRIS ACERO 1013 GAL
ESM5E-1013GR-19L	ESMALTE GRIS ACERO 1013 19LT
ESM5E-1535GR-1L	ESMALTE GRIS ALUMINIO PLUS 1535 1LT
ESM5E-1535GR-4L	ESMALTE GRIS ALUMINIO PLUS 1535 GAL
ESM5E-1535GR-19L	ESMALTE GRIS ALUMINIO PLUS 1535 19LT



ESM5E-1014NG-1L	ESMALTE NEGRO 1014 1LT
ESM5E-1014NG-4L	ESMALTE NEGRO 1014 GAL
ESM5E-1014NG-19L	ESMALTE NEGRO 1014 19 LT
ESM5EP-1523NG-1L	ESMALTE NEGRO PLUS 1523 1LT
ESM5EP-1523NG-4L	ESMALTE NEGRO PLUS 1523 GAL
ESM5EP-1523NG-19L	ESMALTE NEGRO PLUS 1523 19LT



ESM5E-1013RJ-1L	ESMALTE ROJO 1013 1LT
ESM5E-1013RJ-4L	ESMALTE ROJO 1013 GAL
ESM5E-1013RJ-19L	ESMALTE ROJO 1013 19LT
ESM5EP-1530RJ-1L	ESMALTE ROJO PLUS 1530 1LT
ESM5EP-1530RJ-4L	ESMALTE ROJO PLUS 1530 GAL
ESM5EP-1530RJ-19L	ESMALTE ROJO PLUS 1530 19LT

PRIMARIOS ANTICORROSIVOS



* PRIMARIO BASE

(Blanco, Gris, Rojo óxido y Negro)

PRESENTACIÓN: Litro, Galón, Cubeta

USO: Protección de piezas y superficies metálicas ferrosas, se puede utilizar sobre lámina galvanizada.



PR-5000-1LT	PRIMER BLANCO 5000 1LT
PR-5000-4LT	PRIMER BLANCO 5000 GAL
PR-5000-19LT	PRIMER BLANCO 5000 19LT



PR-5002-1LT	PRIMER GRIS 5002 1LT
PR-5002-4LT	PRIMER GRIS 5002 GAL
PR-5002-19LT	PRIMER GRIS 5002 19LT



PR-5007-1LT	PRIMER GRIS SECADO RAPIDO 5007 1 LT
PR-5007-4LT	PRIMER GRIS SECADO RAPIDO 5007 GAL
PR-5007-19LT	PRIMER GRIS SECADO RAPIDO 5007 19LT



PR-5003-1LT	PRIMER NEGRO 5003 19LT
PR-5003-4LT	PRIMER NEGRO 5003 GAL
PR-5003-19LT	PRIMER NEGRO 5003 19LT



PR-5001-1LT	PRIMER ROJO OXIDO 5001 1LT
PR-5001-4LT	PRIMER ROJO OXIDO 5001 GAL
PR-5001-19LT	PRIMER ROJO OXIDO 5001 19LT

*Estos colores son aproximados a los reales.

COLOR PARA CEMENTO



Color para cemento

Alta resistencia a la intemperie y a la luz solar. Brinda colores firmes y durable en pisos de concreto, muros, mosaicos, adoquín, fabricación de artesanías.

*Estos colores son aproximados a los reales.



COLCAFCEM COLORANTE
"CAFE" P/CEM



COLAZULRCM COLORANTE
"AZULREY" P/CEM



CCOLNEGCEM COLORANTE
"NEGRO" P/CEM



CCOLROJCEM COLORANTE
"ROJO" P/CEM

BROCHAS

Cerdas más finas que brindan mejor acabado y una mayor aplicación de pintura con mango ligero para un trabajo más cómodo, resina epóxica que minimiza la caída de las cerdas. Con orificio en el mango para colgar.



14480	BROCHA 1/2 CON MANGO DE PLASTICO BRT-1/2
14481	BROCHA 1 CON MANGO DE PLASTICO BRT-1
14482	BROCHA 1-1/2 CON MANGO DE PLASTICO BRT-1-1/2
14483	BROCHA 2 CON MANGO DE PLASTICO BRT-2
14484	BROCHA 2-1/2 CON MANGO DE PLASTICO BRT-2-1/2
14485	BROCHA 3 CON MANGO DE PLASTICO BRT-3
14486	BROCHA 4 CON MANGO DE PLASTICO BRT-4
14487	BROCHA 5 CON MANGO DE PLASTICO BRT-5
14488	BROCHA 6 CON MANGO DE PLASTICO BRT-6

Cerdas más finas que brindan mejor acabado y una mayor aplicación de pintura con mango ligero para un trabajo más cómodo. Resina epóxica que minimiza la caída de las cerdas con orificio en el mango para colgar.



21524	BROCHA CON MANGO DE PLASTICO, 1/2, PRETUL BRP-1/2
21524	BROCHA CON MANGO DE PLASTICO, 1, PRETUL BRP-1
21525	BROCHA CON MANGO DE PLASTICO, 1-1/2, PRETUL BRP-1-1/2
21526	BROCHA CON MANGO DE PLASTICO, 2, PRETUL BRP-2
21527	BROCHA CON MANGO DE PLASTICO, 2-1/2, PRETUL BRP-2-1/2
21528	BROCHA CON MANGO DE PLASTICO, 3, PRETUL BRP-3
21529	BROCHA CON MANGO DE PLASTICO, 4, PRETUL BRP-4
21530	BROCHA CON MANGO DE PLASTICO, 5, PRETUL BRP-5
21531	BROCHA CON MANGO DE PLASTICO, 6, PRETUL BRP-6

MANERAL PARA RODILLO



19255	MANERAL P/RODILLO PARA PINTAR 9 MAJA-9
10742	MANERAL PARA MINI RODILLO MAROD-371

MATERIAL: Acero con varilla central de 6 mm
Mango fabricado en polipropileno con adaptador para extensión.

CHAROLA PARA RODILLO



19211	CHAROLA DE PLASTICO PARA RODILLO CHAP-14
-------	--

Fabricada en polipropileno alto impacto color negro con gancho para escalera.
Para rodillos hasta 9" (23 cm)

CUÑA SIN MANGO



21640	CUÑA DE 4 X 3", SIN MANGO, PRETUL
21641	CUÑA DE 4 x 5", SIN MANGO, PRETUL

Hojas de acero de alta flexibilidad, con acabado azulado, esquinas superiores redondeadas.
Sin mango.

CEPILLO DE ALAMBRE



10656	CEPILLO DE ALAMBRE CERDAS DE ACERO INOX CEA-54I
11553	CEPILLO DE ALAMBRE CON MANGO, 3X17PINCELES CEA-18
11559	CEPILLO DE ALAMBRE CON MANGO, 4X16 PINCELES CEA-54

Cerdas fabricadas con alambre de acero inoxidable de alta resistencia. Mango ergonómico ideal para limpiar sin contaminar, retira excedente de soldadura, óxido, limpieza de fundición, para desbastar grandes áreas planas en menos tiempo.

CEPILLO DE ALAMBRE



11539 CEPILLO DE ALAMBRE CON MANGO Y ESPATULA, 3X17 PINCELES CEA-18E

Cerdas fabricadas con alambre de acero al carbono de alta resistencia. Mango fabricado en polipropileno. Remueve pintura vieja, óxido, hollín para limpiar superficies de concreto metal y madera.

CEPILLO DE ALAMBRE



20653 CEPILLO ALAMBRE, 64 PINCELES, PRETUL CEA-54P

Cerdas fabricadas con alambre de acero al carbono de alta resistencia con mango fabricado en polipropileno. Remueve pintura vieja, óxido, hollín. Para limpiar superficies de concreto metal y madera.

CEPILLO DE ALAMBRE



11556 CEPILLO DE ALAMBRE, 6X19 PINCELES CEA-36

Cerdas fabricadas con alambre de acero al carbono de alta resistencia, base fabricada en polipropileno, Ideal para remover óxido y pintura de superficies metálicas.

PLASTI PROTECTOR



11109 PLASTIPROTECTOR USO LIGERO PLAP-15L

11108 PLASTIPROTECTOR USO RUDO PLAP-10R

Fabricados en polietileno Ideal para proteger muebles, pisos y equipos, de pintura, polvo y manchas.

PISTOLA DE BAJA PRESIÓN



19000 PISTOLA PARA PINTAR, BAJA PRESION, VASO DE ALUMINIO PIPI-26

Ideal para trabajos de carpintería y herrería, cuerpo y vaso de aluminio pulido de 1 L. Tubería de acero y boquilla de acero inoxidable. Fácil limpieza, desarmado sencillo que facilita el mantenimiento.

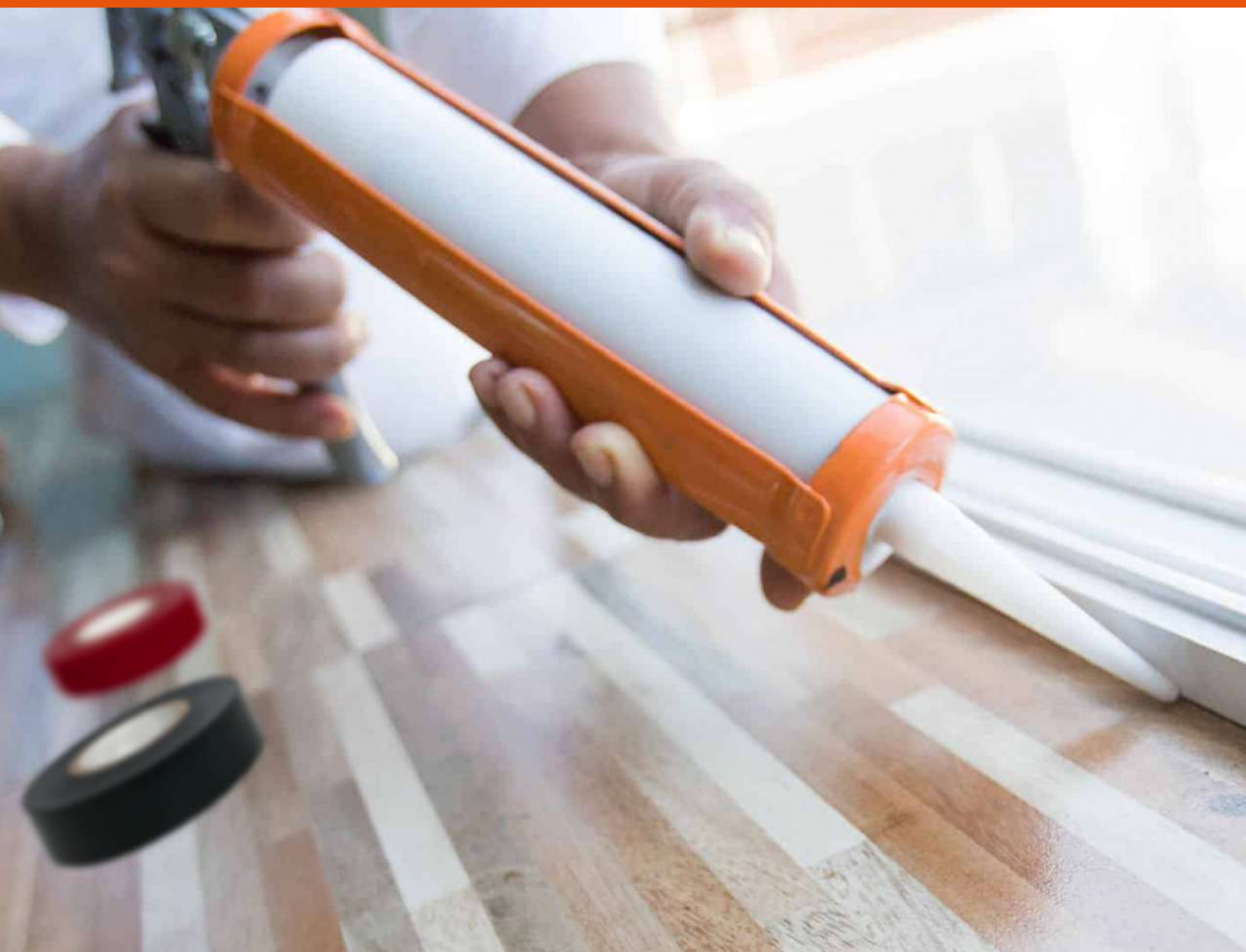

**LÍNEA DE
CINTAS Y
SELLADORES**

MASKING TAPE



12620	MASKING TAPE, 1/2, AZUL MSK-1/2A
12621	MASKING TAPE, 3/4, AZUL MSK-3/4A
12622	MASKING TAPE, 1, AZUL MSK-1A
12623	MASKING TAPE, 1-1/2, AZUL MSK-1-1/2A
12624	MASKING TAPE, 2, AZUL MSK-2A

Fabricadas con papel crepado adhesivos de caucho sintético / natural. Resistentes a la luz solar. Ideales para trabajos arquitectónicos y contratistas que requieren permanencia hasta por 2 semanas sin dejar residuos.

CINTA DE AISLAR



12500	CINTA DE AISLAR # 33, 18M, NEGRA M-33
12502	CINTA DE AISLAR # 33, 18M, VERDE M-33V
12503	CINTA DE AISLAR # 33, 18M, AMARILLA M-33A
12504	CINTA DE AISLAR # 33, 18M, ROJA M-33R
12505	CINTA DE AISLAR # 33, 18M, AZUL M-33Z
12506	CINTA DE AISLAR # 33, 18M, BLANCA M-33B
12507	CINTA DE AISLAR # 33, 18M, GRIS M-33G

Cintas fabricadas en PVC con base de adhesivo acrílico. Retardantes de flama. Inhiben la corrosión de conductores eléctricos. Aislamiento eléctrico en alambres y cables.

CINTA PARA DUCTO



12586	CINTA PARA DUCTO, 10 M, RESISTENTE A ALTAS TEMPERATURAS CDU-10X
12587	CINTA PARA DUCTO, 30 M, RESISTENTE A ALTAS TEMPERATURAS CDU-30X
12588	CINTA PARA DUCTO, 50 M, RESISTENTE A ALTAS TEMPERATURAS CDU-50X

Cinta de polietileno reforzado con malla de algodón de 48mm de ancho. Elongación min.10%.

CINTAS MASKING TAPE



12589	CINTA MASKING TAPE, 1/2 MSK-1/2
12590	CINTA MASKING TAPE, 3/4 MSK-3/4
12591	CINTA MASKING TAPE, 1 MSK-1
12592	CINTA MASKING TAPE, 1-1/2 MSK-1-1/2
12593	CINTA MASKING TAPE, 2 MSK-2

Fabricados de papel de alta resistencia, longitud 50m, para uso general.

ESPUMA EXPANSIVA



10919	ESPUMA EXPANSIVA, 300 ML ESEX-300
10920	ESPUMA EXPANSIVA, 500 ML ESEX-500

Espuma de poliuretano, aíslan y sellan contra humedad, frío, ruido, roedores e insectos.

Para rellenar juntas en marcos, ventanas y puertas.

Sellador 100 % silicón



17559	SELLADOR TRANSPARENTE, 100% DE SILICÓN 280 ML SIL - 100T
17560	SELLADOR BLANCO, 100% DE SILICÓN, 280ML, SIL -100B
17561	SELLADOR NEGRO, 100% DE SILICÓN, 280 ML, SIL -100N
17562	SELLADOR TRANSPARENTE, 100% DE SILICÓN, 85 GR SIL-85T

Uso general en interiores y exteriores.
Para superficies lisas como: vidrio, aluminio, cerámica, porcelana, madera, hierro, etc.

Sellador para baños y cocinas



18565	SELLADOR TRANSPARENTE PARA BAÑO Y COCINA, 280 ML SIL - 100 BCT
18566	SELLADOR BLANCO PARA BAÑO Y COCINA, 280 ML SIL-100 BCB
18567	SELLADOR TRANSPARENTE PARA BAÑO Y COCINA, 85 GR SIL - 85 BCT
18568	SELLADOR BLANCO PARA BAÑO Y COCINA, 85 GR SIL 85 BCB

Para superficies como:
Cerámica, porcelana, vidrio, azulejo, formaica, aluminio, acero inoxidable, madera, etc.
Evita la formación de hongos.
Para uso de interiores y exteriores.

Sellador acrílico



18569	SELLADOR ACRILICO 280 ML TRANSPARENTE SACRI - 100T
18570	SELLADOR ACRILICO 280 ML BLANCO SACRI-100B

Uso general en interiores y exteriores
Para superficies lisas y porosas como: tabique, fibrocemento, panel de yeso, ladrillo, madera, concreto, y aluminio.
Una vez curado puede usar pintura (base agua, acrílica y vinílica)
No usar en aplicaciones donde se encuentra sumergido en agua

Selladores de silicón para altas temperaturas



17566	SELLADOR PARA ALTAS TEMPERATURAS, SILICON ROJO, 85 GR ALTE-R
17567	SELLADOR PARA ALTAS TEMPERATURAS, SILICON NEGRO, 85 GR ALTE-N
17568	SELLADOR PARA ALTAS TEMPERATURAS, SILICON AZUL, 85 GR ALTE-A

Vulcaniza a temperatura ambiente
Resisten en temperaturas de -50 °C a 250 °C
Se mantienen flexibles aun después de su aplicación



**LÍNEA DE
ABRASIVOS CORTE
Y DESBASTE**

DISCO DE DIAMANTE



DISCO DIAMANTE SEGMENTADO USO GENERAL EASYCUT-AUSTROMEX

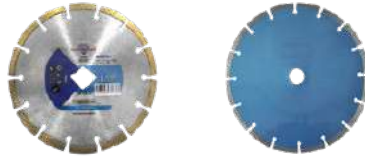

DISCO DIAM SEGM CONCR 14 X 1" (10) AUSTROMEX-HUM



1503 DISCO DIAMANTE 7 (1503)

MODELO:1503
MEDIDAS: 7X0.08X7/8
ABRASIVO: Diamante
USO: Esmeriladora Angular, Sierra Circular.

1507 DISCO DIAMANTE 7 DENTADO (1507)

1509 DISCO DIAMANTE 9 DENTADO (1509)

MODELO:1507-1509
* DISCO DIAMANTE 7X7/8"(7) DENTADO
* DISCO DIAMANTE 9X7/8"(7) DENTADO
ABRASIVO: Diamante
Uso: Esmeriladora Angular, Sierra Circular.

1518 DISCO DIAMANTE 14 NARANJA SEGM CORTE CONCRETO CURADO (1518)

MODELO:1518
ABRASIVO: concreto
MEDIDA: 14" X 0.12" X 1"
USO: cortadora de piso de baja potencia, para corte de concreto curado, piso, segmentos soldados con laser.

DISCO CORTE METAL



DISCO CORTE 4 1/2



DISCO PLANO PARA CORTE TOTAL CUT



566 DISCO CORTE METAL 4 1/2 (566)

567 DISCO CORTE METAL 7 (567)

568 DISCO CORTE METAL 9" (568)

MODELOS: 566-567- 568
*DISCO CORTE METAL 4 1/2 (566)
*DISCO CORTE METAL 7 (567)
*DISCO CORTE METAL 9" (568)
CARACTERÍSTICAS: Su pureza química garantiza su uso en cualquier tipo de acero inoxidable, evita la corrosión y reduce la resistencia a la fatiga.
BENEFICIOS: Su diseño aumenta el tiempo de vida útil y la capacidad de corte limpio.

701 DISCO CORTE 4 1/2 (701) (3501)

877 DISCO CORTE 7 (877)

MODELOS: 701-877
*DISCO CORTE 4 1/2 (701) (3501)
*DISCO CORTE 7 (877)
CARACTERÍSTICAS: Súper delgados y muy seguros.
BENEFICIOS: Poco desarrollo de rebanadas. Gran rapidez de corte. Corte frío.

708 DISCO MULTIPROPÓSITO 4 1/2

MODELO: 708
CARACTERÍSTICAS: Delgado.
BENEFICIOS: Excelente rendimiento, no se tapa, para corte multipropósito.

DISCO CORTE PRECISO 4 1/2"



701 DISCO CORTE PRECISO 4 1/2" (709)

781 DISCO CORTE PRECISO 4 1/2" (781)

MODELOS: 709-781

CARACTERISTICAS: Su pureza química garantiza su uso en cualquier tipo de acero inoxidable, evita la corrosión y reduce la resistencia a la fatiga.

BENEFICIOS: Su diseño aumenta el tiempo de vida útil y la capacidad de corte limpio.

DISCO CORTE METAL 4 1/2



710 DISCO CORTE METAL 4 1/2 (710)

MODELO: 710

CARACTERISTICAS: Súper delgados y muy seguros.

BENEFICIOS: Poco desarrollo de rebanadas. Gran rapidez de corte. Corte frío.

DISCO PLANO DE CORTE



733 DISCO CORTE 14 (733)

MODELO: 733

MEDIDA: 14 x 1/8 x 1

ABRASIVO: Óxido de aluminio

BENEFICIOS: Disco muy suave recomendado para el corte de materiales de metal sólido como barras circulares, cuadradas y soleras.

DISCO DE CORTE METAL 14"



742 DISCO CORTE 14 (742)

744 DISCO CORTE 14 (744)

758 DISCO CORTE 14 (758)

MODELOS: 742- 744- 758

MEDIDA: 14X 1/8 X 1"

ABRASIVO: Óxido de aluminio.

BENEFICIOS: Para corte rápido de aceros estructurales y fundición, recomendado para cortar secciones sólidas. Máximo rendimiento en operaciones severas.

DISCO SUPER PRECISO PARA CORTE ACERO INOXIDABLE



751 DISCO CORTE INDUSTRIAL
4 1/2 (751)

MODELO: 751

MEDIDAS: 4 1/2 x 3/64 x 7/8

ABRASIVO: Óxido de aluminio.

CARACTERÍSTICAS: Súper delgados y muy seguros.

BENEFICIOS: Poco desarrollo de rebanadas. Gran rapidez de corte. Corte frío.

DISCO DE CORTE PARA METAL 4 1/2



778 DISCO DE CORTE PARA
METAL 4 1/2 (778)

MODELO: 778

CARACTERISTICAS: Súper delgados y muy seguros.

BENEFICIOS: Poco desarrollo de rebanadas. Gran rapidez de corte. Corte frío.

DISCO DE CORTE EASYCUT-AUSTROMEX



2006	DISCO CORTE 4 1/2 (2006)
2008	DISCO CORTE 7 (2008)
2010	DISCO CORTE 9 (2010)

MODELOS :2006-2008-2010
 ABRASIVO: De Corte
 MEDIDA:
 * DISCO CORTE 4 1/2X1/8X7/8" (2006)
 * DISCO CORTE 7X1/8X7/8" (2008)
 * DISCO CORTE 9X1/8X7/8" (2010)
 USO: Esmeriladora angular, para corte de metal.

DISCOS CORTE PRECISO EASYCUT-AUSTROMEX



2014	DISCO CORTE PRECISO 4 1/2 (2014)
2015	DISCO CORTE PRECISO 4 1/2 (2015)

MODELOS :2014 -2015
 ABRASIVO: Corte Metal Preciso
 MEDIDA:
 * DISCO CORTE PRECISO 4 1/2X3/64X7/8 (2014)
 * DISCO CORTE PRECISO A/INOX 4 1/2X3/64X7/8 (2015)
 USO: Esmeriladora angular, para superficies aptas en metal.

DISCO CORTE METAL OXIDO ALUM CON CENTRO PLANO EASYCUT- AUSTROMEX



2018	DISCO DE CORTE 7 (2018)
------	-------------------------

MODELOS :2018
 ABRASIVO: Óxido de Aluminio
 MEDIDA: 7 " x 1/16 " x 7/8 "
 USO: Esmeriladora angular, para superficies aptas en metal.

DISCO CORTE ACERO INOXI- DABLE CON CENTRO PLANO EASYCUT-AUSTROMEX



2019	DISCO DE CORTE 7" (2019)
------	--------------------------

MODELOS :2019
 ABRASIVO: Óxido de Aluminio
 MEDIDA: 7 " x 1/16 " x 7/8 "
 USO: Esmeriladora angular, para superficies aptas en acero inoxidable.

DISCO DE CORTE ACERO INOXIDABLE IMPERIAL AUSTROMEX



3302	DISCO CORTE 4 1/2 (3302)
------	--------------------------

MODELO: 3302
 MEDIDA: 4 1/2"
 USO: Esmeriladora angular

DISCO CORTE METAL A/ CARB EC 9X7/8" EASYCUT-AUSTROMEX



2020	DISCO DE CORTE 9 2020
------	-----------------------

MODELOS :2020
 ABRASIVO: Óxido de Aluminio
 MEDIDA: 230 x 1.9 x 22.23.
 USO: Esmeriladora angular, para corte de metal.

DISCOS DESBASTE METAL EASY-CUT-AUSTROMEX



2004	DISCO DESBASTE 4 1/2 (2004)
2007	DISCO DESBASTE 7 (2007)
2009	DISCO DESBASTE 9 (2009)

MODELOS :2004-2007-2009-2010

ABRASIVO: Desbaste

MEDIDAS:

* DISCO DESBASTE 4 1/2X1/4X7/8" (2004)

* DISCO DESBASTE 7X1/4X7/8" (2007)

* DISCO DESBASTE 9X1/4X7/8" (2009)

USO: Esmeriladora angular, para superficies aptas en Metal.

DISCO DESBASTE METAL



560	DISCO DESBASTE METAL 4 1/2 (560)
561	DISCO DESBASTE METAL 7X1/4X7/8 (561)
562	DISCO DE CUBO 9" HUM (562)

MODELOS: 560, 561.

*DISCO DESBASTE METAL 4 1/2 (560)

*DISCO DESBASTE METAL 7X1/4X7/8 (561)

CARACTERÍSTICAS: Su pureza química garantiza su uso en cualquier tipo de acero inoxidable, evita la corrosión y reduce la resistencia a la fatiga.

BENEFICIOS: Su diseño aumenta el tiempo de vida útil y la capacidad de corte limpio.

DISCO LAMINADO PLASTICO HUM EASYCUT-AUSTROMEX



2216	DISCO LAMINADO 4 1/2,GRANO 40 HUM (2216)
2217	DISCO LAMINADO 4 1/2, GRANO 60 HUM (2217)
2218	DISCO LAMINADO 4 1/2, GRANO 80 HUM" (2218)

MODELOS :2216-2217-2218

ABRASIVO: Desbaste

MEDIDAS:

* DISCO LAMINADO 4 1/2X7/8" G-40 HUM (2216)

* DISCO LAMINADO 4 1/2X7/8" G-60 HUM (2217)

* DISCO LAMINADO 4 1/2X7/8" G-80 HUM (2218)

USO: Esmeriladora angular portátil, Mini esmeriladora angular, para desbaste de acero inoxidable, aceros duros, soldaduras y para limpiar superficies oxidadas o pintadas.

DISCO CORTE METAL



8136	DISCO CORTE 4 1/2 CINASA (8136)
------	---------------------------------

MODELOS: 8136

CARACTERÍSTICAS: Su pureza química garantiza su uso en cualquier tipo de acero inoxidable, evita la corrosión y reduce la resistencia a la fatiga.

Dimensiones

4 1/2"X.039"X7/8" 115X1.0X22.2mm

SOLDADURA FLEX



SOLDA6013003VFA	KG SOLDADURA 6013 1/8 FLEX ARC VERDE
SOL6013332GFA	KG SOLDADURA 6013 3/32 FLEX ARC GRIS
SOLDA7018003GFA	KG SOLDADURA 7018 1/8 FLEX ARC GRIS

SOLDADURA INFRA



SOLDA001	KG SOLDADURA 6013 1/8 INFRA PUNTA NARANJA
SOLD6013003VL	KG SOLDADURA 6013 1/8 INFRA VERDE (EXCEL ARC)
SOLD7018003IK	KG SOLDADURA 7018 1/8 INFRA
SOLD7018004IK	KG SOLDADURA 7018 3/32 INFRA

SEGUETAS



18100	SEGUETA BIMETALICA PARA ARCO, 18 DPP, SBI-18
18101	SEGUETA BIMETALICA PARA ARCO, 24 DPP, SBI-24

Segueta bimetalica para arco de acero especial, alta velocidad.
De 18 y 24 dientes. Varias marcas.
Usos: Para cortes de diversos materiales.

**LIJAS PARA MADERA,
PAPEL CABINET**

9"x11"



11606	LIJA PARA MADERA, GRANO 36 LIMA-36
11607	LIJA PARA MADERA, GRANO 40 LIMA-40
11608	LIJA PARA MADERA, GRANO 50 LIMA-50
11609	LIJA PARA MADERA, GRANO 60 LIMA-60
11610	LIJA PARA MADERA, GRANO 80 LIMA-80
11611	LIJA PARA MADERA, GRANO 100 LIMA-100
11612	LIJA PARA MADERA, GRANO 120 LIMA-120
11613	LIJA PARA MADERA, GRANO 150 LIMA-150
11614	LIJA PARA MADERA, GRANO 180 LIMA-180

Para usarse a mano o en máquina.
*Óxido de aluminio.

**LIJAS DE AGUA
MICROFINAS**

9"x11"



11632	LIJA DE AGUA, GRANO 1000 LIAG-1000
11634	LIJA DE AGUA, GRANO 1200 LIAG-1200
11647	LIJA DE AGUA GRANO 1500 LIAG-1500
11648	LIJA DE AGUA GRANO 2000 LIAG-2000

Para usarse a mano o en máquina.

**HOJA DE LIJA
DE AGUA**

9"x11"



11646	LIJA DE AGUA GRANO 60 LIAG-60
11618	LIJA DE AGUA, GRANO 80 LIAG-80
11619	LIJA DE AGUA, GRANO 100 LIAG-100
11620	LIJA DE AGUA, GRANO 120 LIAG-120
11621	LIJA DE AGUA, GRANO 150 LIAG-150
11622	LIJA DE AGUA, GRANO 180 LIAG-180
11623	LIJA DE AGUA, GRANO 220 LIAG-220
11625	LIJA DE AGUA, GRANO 280 LIAG-280
11626	LIJA DE AGUA, GRANO 320 LIAG-320
11627	LIJA DE AGUA, GRANO 360 LIAG-360
11629	LIJA DE AGUA, GRANO 500 LIAG-500

Fabricadas de carburo de silicio con respaldo de papel impermeable lijado en húmedo que evita el tapado prematuro.

USO: Para plásticos, lacas, pintura, vidrio, metal ferroso y no ferroso.

LIJAS

HOJA LIJA DE ESMERIL NEGRA

9"x11"



11600	LIJA DE ESMERIL, GRANO 36 LIME-36
11601	LIJA DE ESMERIL, GRANO 50 LIME-50
11602	LIJA DE ESMERIL, GRANO 80 LIME-80
11603	LIJA DE ESMERIL, GRANO 120 LIME-120

Fabricadas de óxido de aluminio. Para eliminar corrosión y rebabas.

USO: Para lacas, pintura, metal ferroso y no ferroso.

HOJA LIJA DE ESMERIL ROJA

9"x11"



11640	LIJA DE ESMERIL ROJA, GRANO 36 LIMER-36
11641	LIJA DE ESMERIL ROJA, GRANO 50 LIMER-50
11642	LIJA DE ESMERIL ROJA, GRANO 80 LIMER-80
11643	LIJA DE ESMERIL ROJA, GRANO 120 LIMER-120
11644	LIJA DE ESMERIL GRANO 40 ROJA LIMER-40
11645	LIJA DE ESMERIL GRANO 100 ROJA LIMER-100

Fabricadas de óxido de aluminio con respaldo de tela.

USO: Plástico, lacas, pintura y metal no ferroso.

LIMA DE MEDIA CAÑA BASTARDA CON MANGO



15317	LIMA DE MEDIA CAÑA, BASTARDA, 6, CON MGO LMCB-6T
15318	LIMA DE MEDIA CAÑA, BASTARDA, 8, CON MGO LMCB-8T

Tienen dientes grandes que sirven para dar un mayor desbaste.

USO: Para desbaste en superficies planas y cóncavas. Superficies curvadas, planas y esquinas.

LIMA DE MEDIA CAÑA BASTARDA



15169	LIMA MEDIA CAÑA, BASTARDA,6 LMCB-6
15171	LIMA MEDIA CAÑA, BASTARDA,8 LMCB-8
15173	LIMA MEDIA CAÑA, BASTARDA,10 LMCB-10
15175	LIMA MEDIA CAÑA, BASTARDA,12 LMCB-12

Picado doble para desbaste rápido. Ahusadas en anchura y espesor
USO: Para desbastes en superficies planas y cóncavas.

LIMA PLANA BASTARDA



15144	LIMA PLANA, BASTARDA, 10 LPB-10
15146	LIMA PLANA, BASTARDA, 12 LPB-12
15148	LIMA PLANA, BASTARDA, 14 LPB-14

Picado doble para desbaste rápido
USO: Superficies planas y esquinas.

TRIÁNGULO PESADO, BASTARDAS CON MANGO



15307	LIMA TRIANGULO PESADO, 6, MGO INYECCION LTP-6T
15308	LIMA TRIANGULO PESADO, 8, MGO INYECCION LTP-8T

Dureza y geometría homogénea en el corte
Para ángulo, esquinas y surcos

TRIÁNGULO PESADO, BASTARDAS



15126	LIMA TRIANGULO PESADO, 4 LTP-4
15119	LIMA TRIANGULO PESADO, 5 LTP-5
15123	LIMA TRIANGULO PESADO, BASTARDA, 6 LTP-6
15124	LIMA TRIANGULO PESADO, BASTARDA, 7 LTP-7
15125	LIMA TRIANGULO PESADO, 8 LTP-8

Corte doble para debaste rápido
Para acabados finos

CARDA TRENZADA



17527	CARDA CIR. TRENZADA P/ESMERILADORA 4 CATR-4ES
17528	CARDA CIR. TRENZADA P/ESMERILADORA 8 CATR-8E

Cerdas fabricadas con alambre de acero al carbono de alta resistencia. Mango fabricado en polipropileno. Remueve pintura vieja, óxido, hollín para limpiar superficies de concreto metal y madera.

CARDA CIRCULAR ALAMBRE FINO



11573	CARDA CIRCULAR 1-1/2, ALAMBRE FINO, PARA TALADRO CA-1-1/2F
11574	CARDA CIRCULAR 2, ALAMBRE FINO, PARA TALADRO CA-2F
11575	CARDA CIRCULAR 3, ALAMBRE FINO, PARA TALADRO CA-3F
11576	CARDA CIRCULAR 4, ALAMBRE FINO, PARA TALADRO CA-4F

Alambres finos ondulados de acero latonado, para pulir y quitar residuos de pintura. Para usarse con taladros eléctricos.

CARDA DE COPA ALAMBRE FINO



11591	CARDA DE COPA, ALAMBRE FINO, 1-3/4 PARA TALADRO CO-1-3/4F
11592	CARDA DE COPA, ALAMBRE FINO, 2-3/4 PARA TALADRO CO-2-3/4F

Alambres finos de acero latonado, para pulir y quitar residuos de pintura. Para usarse con taladros eléctricos.

CARDA DE COPA ALAMBRE ONDULADO



11535	CARDA DE COPA, ALAMBRE ONDULADO, 5 PARA ESMERIL CO-512
11538	CARDA DE COPA, ALAMBRE ONDULADO, 5, MILIMETRICA PARA ESMERIL CO-512M

Fabricadas de acero al carbono, acabado medio. Para superficies irregulares en limpieza de metales, eliminación de óxido y rebabas. Ideal para esmeriladora de 4 1/2".

CARDA DE COPA ALAMBRE TRENZADO



17530	CARDA COPA TRENZADA 3, M14, ESP. 0,5MM CT-608MX
17532	CARDA COPA TRENZADA 4, M14, ESP. 0,5MM CT-610MX

Fabricadas de acero al carbono, acabado burdo. Para trabajo pesado y desbaste rápido como limpieza de metales y cordones de soldadura.



LÍNEA DE
SEGURIDAD

PROTECCIÓN FACIAL

CARETA PARA SOLDAR



13729 CARETA PARA SOLDAR, ERGONOMICA CASO-3

Fabricada en nylon.
Ventanilla móvil que permite visualizar constantemente el área de trabajo.
Protección completa de cabeza y cuello.
Lentes intercambiables para sombras no. 10 a 14.
Incluye lente sombra no. 12.

CARETA PARA SOLDAR



26005 CARETA PARA SOLDAR, PRETUL CASO-300-P

Fabricada de polipropileno.
Ventanilla móvil que permite visualizar constantemente el área de trabajo.
Lentes intercambiables para sombras no. 10 a 14
Incluye lente sombra no. 12

CARETA BÁSICA PARA SOLDAR



WT52876 CARETA PARA SOLDAR CON ANTIFAZ

Careta tipo antifaz recomendable para los que prefieren una careta sencilla, elaborada de plástico polipropileno.

CARETA ELECTRÓNICA PARA SOLDAR



17457 CARETA ELECTRÓNICA PARA SOLDAR, MODELO FUEGO CAREL-913F

Fabricada de polipropileno
4 sensores de arco para una respuesta rápida y exacta a los cambios de intensidad luminosa desde cualquier ángulo.

CARETA ELECTRÓNICA PARA SOLDAR



17460 CARETA ELECTRÓNICA PARA SOLDAR, SOMBRA 9 A 13 CAREL-913X

Fabricada de polipropileno
4 sensores de arco para una respuesta rápida y exacta a los cambios de intensidad luminosa desde cualquier ángulo.

GAFAS PARA SOLDAR



14282 GAFAS PARA SOLDAR GASO

4 válvulas de ventilación
Puede usarse con lentes graduados.
Uso en oxicorte y corte por plasma
Incluye lente sombra no. 6.

LENTE DE SEGURIDAD



10828	LENTE DE SEGURIDAD GRIS LEDE-XN
-------	---------------------------------

Mica 100% de policarbonato resistente a impactos.
 Puente y armazón suave con diseño cómodo y deportivo.
 Protección UV y antirayaduras.
 Permiten que los ojos se adapten fácilmente en interiores y exteriores.

LENTE DE SEGURIDAD



15290	LENTE DE SEGURIDAD LIGEROS GRIS LEN-LN
-------	--

Mica 100% policarbonato con protección UV y antirayadura. Diseño ultraligero.
 Útiles en industria, construcción, taller y hogar.

LENTE DE SEGURIDAD



20402	LENTE DE SEGURIDAD, COLOR GRIS, PRETUL LEN-SN-P
-------	---

Mica 100% policarbonato con protección UV y antirayaduras.
 Útiles en el manejo de máquinas eléctricas, industria, construcción, taller y reparaciones domésticas.

LENTE DE SEGURIDAD



10824	LENTE DEPORTIVOS INTERIOR EXTERIOR LEDE-I/E
-------	---

Mica 100% policarbonato con protección UV y antirayadura
 Puente suave. Útiles en la industria, construcción, taller y reparaciones domésticas.

LENTE DE SEGURIDAD AJUSTABLES



14213	LENTE SEGURIDAD AJUSTABLE MICA NEGRA LEN-2000N
14284	LENTE DE SEGURIDAD AJUSTABLES LEN-2000

Mica 100% policarbonato con protección UV y antirayadura. Útiles en la industria, construcción, taller y reparaciones domésticas.

CRISTAL PARA CARETAS



14274	CRISTAL PARA CARETA CASO-300, SOMBRA 10 CRI-C-10
14275	CRISTAL PARA CARETA CASO-300, SOMBRA 11 CRI-C-11
14276	CRISTAL PARA CARETA CASO-300, SOMBRA 12 CRI-C-12
14277	CRISTAL PARA CARETA CASO-300, SOMBRA 14 CRI-C-14
14278	CRISTAL PARA CARETA CASO-300, TRANSPARENTE CRI-C-TR

Fabricados de policarbonato
 Para caretas de soldar abatibles modelos CASO-3 y CASO-300-P.

PROTECCIÓN FACIAL

CRISTAL PARA GOOGLES



14279	CRISTAL PARA GOGGLES, SOMBRA NO. 6 PARA GASO CRI-G-6
-------	--

Para gafas de soldar modelo GASO.

VIDRIO PARA CARETA

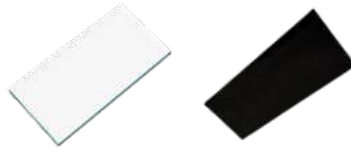

VICL	VIDRIO CLARO
VID14	VIDRIO OSCURO 14

Mica 100% policarbonato con protección UV y antirayadura. Diseño ultraligero. Útiles en industria, construcción, taller y hogar.

PROTECTOR FACIAL



14221	PROTECTOR FACIAL PF-500
-------	-------------------------

Mica de policarbonato flexible, antirayadura. Resistente a impactos. Abatimiento de 90°. Ajuste de matraca.

TAPÓN AUDITIVO REUTILIZABLE



14225	PROTECTOR AUDITIVO TRIPLE BARRERA CON CORDÓN TA-3B
-------	--

Diseño ergonómico confortable, lavable. Termoplástico suave.

CASCO DE SEGURIDAD



14294	CASCO DE SEGURIDAD COLOR AMARILLO CAS-A
14292	CASCO DE SEGURIDAD COLOR NARANJA CAS-N
10370	CASCO DE SEGURIDAD COLOR BLANCO CAS-B
10371	CASCO DE SEGURIDAD COLOR AZUL CAS-Z
10373	CASCO DE SEGURIDAD COLOR ROJO CAS-R
10374	CASCO DE SEGURIDAD COLOR VERDE CAS-V

Casco de seguridad fabricado en polietileno de alta densidad, tipo cachucha. Ajuste de matraca en color amarillo.

TAPÓN AUDITIVO DESECHABLE



14223	PROTECTOR AUDITIVO DE ESPUMA CON CORDON TAC
-------	---

Fabricado de espuma de poliuretano en forma cónica que permite un buen ajuste al cono auditivo.

PROTECCIÓN CORPORAL

GUANTES DE CARNAZA



GUCACO	GUANTE DE CARNAZA CORTO
GUCALA	GUANTE DE CARNAZA LARGO

Para soldadura, herrería y trabajos con metales.

GUANTES PARA SOLDAR



15246	GUANTES PARA SOLDADOR GU-SOL
--------------	------------------------------

Excelente desempeño y protección en la industria metalmeccánica (soldado y formado).

GUANTES PARA SOLDAR



14288	GUANTES PIEL DE CABRA CON DORSO DE CARNAZA GUX-BOVA
--------------	---

Guantes de piel de cabra con dorso de carnaza.

GUANTES DE CARNAZA



15248	GUANTES CARNAZA, USOS GENERALES, CORTO GU-CACE-C
14240	GUANTES CARNAZA, USOS GENERALES, LARGO GU-CACE

Alta flexibilidad y resistencia a la abrasión. Manejo de herramientas eléctricas.

GUANTES DE CARNAZA Y LONETA PREMIUM



14246	GUANTES CARNAZA Y LONETA, CON REFUERZO, GRANDE GU-TECA-R
--------------	--

Refuerzo de carnaza en palma, dedo índice y pulgar brinda resistencia a materiales abrasivos y flexibilidad. Forro interno para mayor confort. Manejo de herramientas eléctricas.

GUANTES DE CARNAZA Y LONETA



14245	GUANTES CARNAZA, Y LONETA GRANDE GU-TECA
--------------	--

Resistencia a materiales abrasivos. Forro interno para mayor confort. Manejo de herramientas eléctricas.

PROTECCIÓN CORPORAL

PETO PARA SOLDAR



13116	PROTECCIÓN PARA SOLDAR, PETO DE CARNAZA
-------	---

Para soldadura, herrería y trabajos con metales.

CHALECOS REFORZADOS MÁXIMA VISIBILIDAD



13479	CHALECO DE SEGURIDAD REFORZADO, CON BOLSAS, NARANJA, MEDIANO CHS-800N-M
13480	CHALECO DE SEGURIDAD REFORZADO, CON BOLSAS, NARANJA, GRANDE CHS-800N-L
13481	CHALECO SEGURIDAD REFORZADO, C/BOLSAS, NARANJA, EXTRA GRANDE CHS-800N-XL
13482	CHALECO DE SEGURIDAD REFORZADO, CON BOLSAS, VERDE, MEDIANO CHS-800V-M
13483	CHALECO DE SEGURIDAD REFORZADO, CON BOLSAS, VERDE, GRANDE CHS-800V-L
13484	CHALECO SEGURIDAD REFORZADO, CON BOLSAS, VERDE, EXTRA GRANDE CHS-800V-XL

Resistente a los rayos UV.

Visibilidad de día: 40 m Visibilidad de noche: 150 m

Peso:120 g/m2 Peso total: 218g

FAJAS CON TIRANTES Y TERCER CINTURÓN, AJUSTABLES



10955	FAJA CON TIRANTES AJUSTABLES Y CINTURON FAJA-SX
10956	FAJA CON TIRANTES AJUSTABLES Y CINTURON FAJA-XLX
14216	FAJA CON TIRANTES Y TERCER CINTURON, AJUSTABLES, TALLA MEDIANA FAJA-MX
14217	FAJA CON TIRANTES Y TERCER CINTURON, AJUSTABLES, TALLA GRANDE FAJA-LX

Tirantes ajustables

4 varillas para soporte lumbar

FAJAS CON TIRANTES AJUSTABLES



14237	FAJA CON TIRANTES AJUSTABLES, TALLA MEDIANA FAJA-M
14238	FAJA CON TIRANTES AJUSTABLES, TALLA GRANDE FAJA-L
10953	FAJA CON TIRANTES AJUSTABLES CHICA FAJA-S
10954	FAJA C/TIRANTES AJUSTABLES EXTRA GRANDE FAJA-XL

Tirantes ajustables

4 varillas para soporte lumbar

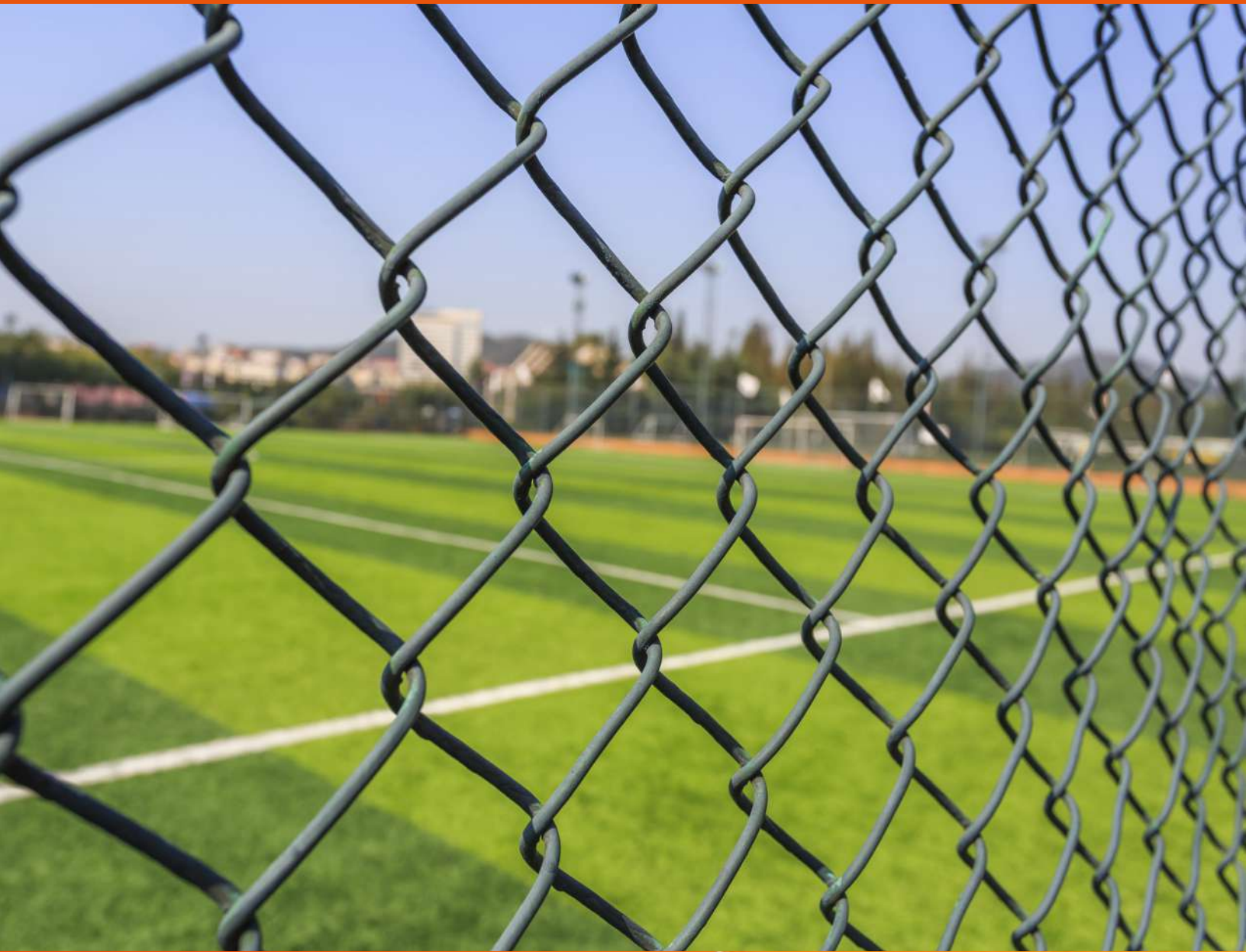

**LÍNEA DE
MALLAS Y
ACCESORIOS**

MALLAS Y ACCESORIOS

MALLA MOSQUITERO

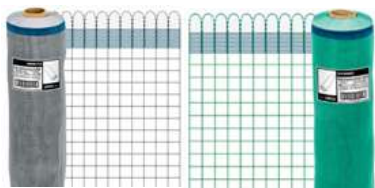

44953M	MALLA MOSQUITERA PLÁSTICA, 1.05 X 30 M, VERDE TEMO-10PV (M)
44954	MALLA MOSQUITERA PLÁSTICA, 1.20 X 30 M, VERDE TEMO-12PV
44962	MALLA MOSQUITERA PLÁSTICA, 1.50 X 30 M, GRIS TEMO-15PG
44962M	MALLA MOSQUITERA PLÁSTICA, 1.50 X 30 M, GRIS TEMO-15PG (M)

Fabricadas en polietileno de alta densidad máxima resistencia a la corrosión y rayos UV. Tejido más grueso, con orillas reforzadas. Prácticas y fáciles de manejar. Previenen la entrada de insectos y mantienen los espacios frescos y ventilados.

MALLA MOSQUITERO GALVANIZADA



MORG214090	MOSQUIERD GALVANIZADA 2.14X0.90 C26
MORG214120	MOSQUIERD GALVANIZADA 2.14X1.20 C26

Es una resistente malla de acero con pequeñas aberturas diseñada para evitar el paso de insectos, ofreciéndole por su fortaleza una mayor seguridad.

TELA MOSQUITERO GALVANIZADA



MOG2209030	TELA MOSQUITERO GALV 0.90X30 M
MOG2210530	TELA MOSQUITERO GALV 1.05X30 M
MOG2212030	TELA MOSQUITERO GALV 1.20X30 M

Formada por delgados alambres de acero tejidos en acabado galvanizado.

MALLA CICLÓN



MALC63100C11	MALLA CICLÓN 69 1.00 C/11
MALC63100C12	MALLA CICLÓN 69 1.00 C/13
MALC63125C11	MALLA CICLÓN 69 1.25 C/11
MALC63125C12	MALLA CICLÓN 69 1.25 C/13
MALC63150C11	MALLA CICLÓN 69 1.50 C/11
MALC63150C12	MALLA CICLÓN 69 1.50 C/13
MALC63175C11	MALLA CICLÓN 69 1.75 C/11
MALC63175C12	MALLA CICLÓN 69 1.75 C/13
MALC63200C11	MALLA CICLÓN 69 2.00 C/11
MALC63200C12	MALLA CICLÓN 69 2.00 C/13
MALC63250C11	MALLA CICLÓN 69 2.50 C/11
MALC63250C13	MALLA CICLÓN 69 2.50 C/13
MALC63300C11	MALLA CICLÓN 69 3.00 C/11
MALC63300C13	MALLA CICLÓN 69 3.00 C/13

MALLAS Y ACCESORIOS

GRAPAS



MEDIDAS GRAPAS				
TIPO	1	1 1/4	1 1/2	KG X CAJA
CORRUGADA				25
LISA				25

CINTA VERDE ROMPEVIENTOS

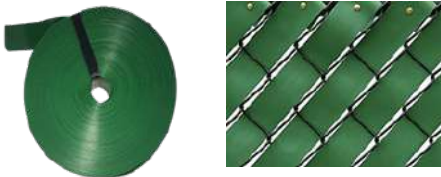

ACCCINROMPVIE010V	CINTA VERDE ROMPEVIENTOS (10 M2)
ACCCINROMPVIE020V	CINTA VERDE ROMPEVIENTOS (20 M2)
ACCCINROMPVIE03V	CINTA VERDE ROMPEVIENTOS (3 M2)
ACCCINROMPVIE08V	CINTA VERDE ROMPEVIENTOS (8 M2)

1 metro de tela rompe vientos cubre 1.5m2.

MALLA BORREGUERA



MALLAB RRE1 .20X50R	MALLA BORREGUERA 1.20X50 ROLLO
MALLABORRE 1.47X	MALLA BORREGUERA 1.40 X 50 ROLLO
MALLABORRE 1.67X	MALLA BORREGUERA 1.67 X 50 ROLLO

Excelente rendimiento por su gran resistencia, más seguridad en delimitación perimetral que otros tipos de cercos. Fácil manejo. La separación de postes permite una distancia de hasta 5 metros. Impide el paso de animales depredadores.

MALLA CRIBA



MALLACRIBA4X4	MALLA CRIBA 4X4 ROLLO 30 MT
MALLACRIBA5X5	MALLA CRIBA 5X5 ROLLO 30 MT
MALLACRIBA6X6	MALLA CRIBA 6X6 ROLLO 30 MT

Malla de acero entretejida y galvanizada por inmersión en caliente con múltiples usos, desde la construcción hasta las artes decorativas.

MALLA HEXAGONAL



44655	MALLA DE ACERO GALVANIZADO HEXAGONAL, 13 MM X 0.90 M MAHE-1309
44658	MALLA DE ACERO GALVANIZADO HEXAGONAL, 25 MM X 1.50 M MAHE-2515
44659	MALLA DE ACERO GALVANIZADO HEXAGONAL, 25 MM X 1.75 M MAHE-2517

Producto altamente resistente a la corrosión debido a su grueso galvanizado. Figura hexagonal de alambre resistente.

CONCERTINA



ACCMCGAL	CONCERTINA GALVANIZADA RESIDENCIAL
ACCMCAG	CONCERTINA GALVANIZADA MILITAR

Alambre galvanizado de alta resistencia, se utiliza para protección perimetral de predios.

ALAMBRE DE PÚAS



ALAMPUAGAL30	ALAMBRE DE PUAS GAL CAL 12.5 30 KG 300M
ALAMPUAGAL34	ALAMBRE DE PUAS GAL CAL 12.5 34 KG 360M

Alambre de púas galvanizado, rollo de 30kg.

TAPÓN SIMPLE PARA TUBO



ACCTSTG2	TAPÓN SIMPLE PARA TUBO GALVANIZADO 2
ACCTSTG2.5	TAPÓN SIMPLE PARA TUBO GALVANIZADO 2 1/2"
ACCTSTG1.5	TAPÓN SIMPLE PARA TUBO GALVANIZADO 1 1/2

Es utilizado como tapón superior en el tubo para la malla ciclón.

TAPÓN PÚA PARA TUBO



ACCTP2	TAPÓN PUA 2
ACCTP2.5	TAPÓN PUA 2 1/2

Se utiliza como tapón en el tubo galvanizado de la malla ciclónica. Sujeta la barra superior.

TAPÓN BARRA PARA TUBO



ACCAPBAR60X42	TAPÓN BARRA 60X42 MM
---------------	----------------------

Tapón o capucha marco aluminio: Se utiliza como tapón en el tubo galvanizado de la malla ciclónica. Sujeta la barra superior.

ABRAZADERA DE ARRANQUE



ACCAA38	ABRAZADERA ARRANQUE 38MM (1 1/2)
---------	----------------------------------

Complemento para sujetar la púa y la barra superior, inferior e intermedia de la malla ciclón, fabricada en lámina galvanizada.

ABRAZADERA DE TENSIÓN



ACCAT38	ABRAZADERA DE TENSIÓN DE LAMINA DE 38MM (1 1/2)
ACCAT48	ABRAZADERA DE TENSIÓN DE LAMINA DE 48MM
ACCAT62	ABRAZADERA DE TENSIÓN DE LAMINA DE 60MM
ACCAT73	ABRAZADERA DE TENSIÓN DE LAMINA DE 73MM

Complemento para sujetar la malla ciclónica, para dar mayor estabilidad, hecha en lámina. Se usa comúnmente para sostener la malla.

ESPADA



ACCESPTG2	ESPADA PARA TUBO GALVANIZADO 2
ACCESPTG2.5	ESPADA PARA TUBO GALVANIZADO 2 1/2

Se utiliza para sujetar 3 hilos de alambre de púa en la malla ciclón.

INSTALACIÓN DE MALLA CICLÓNICA

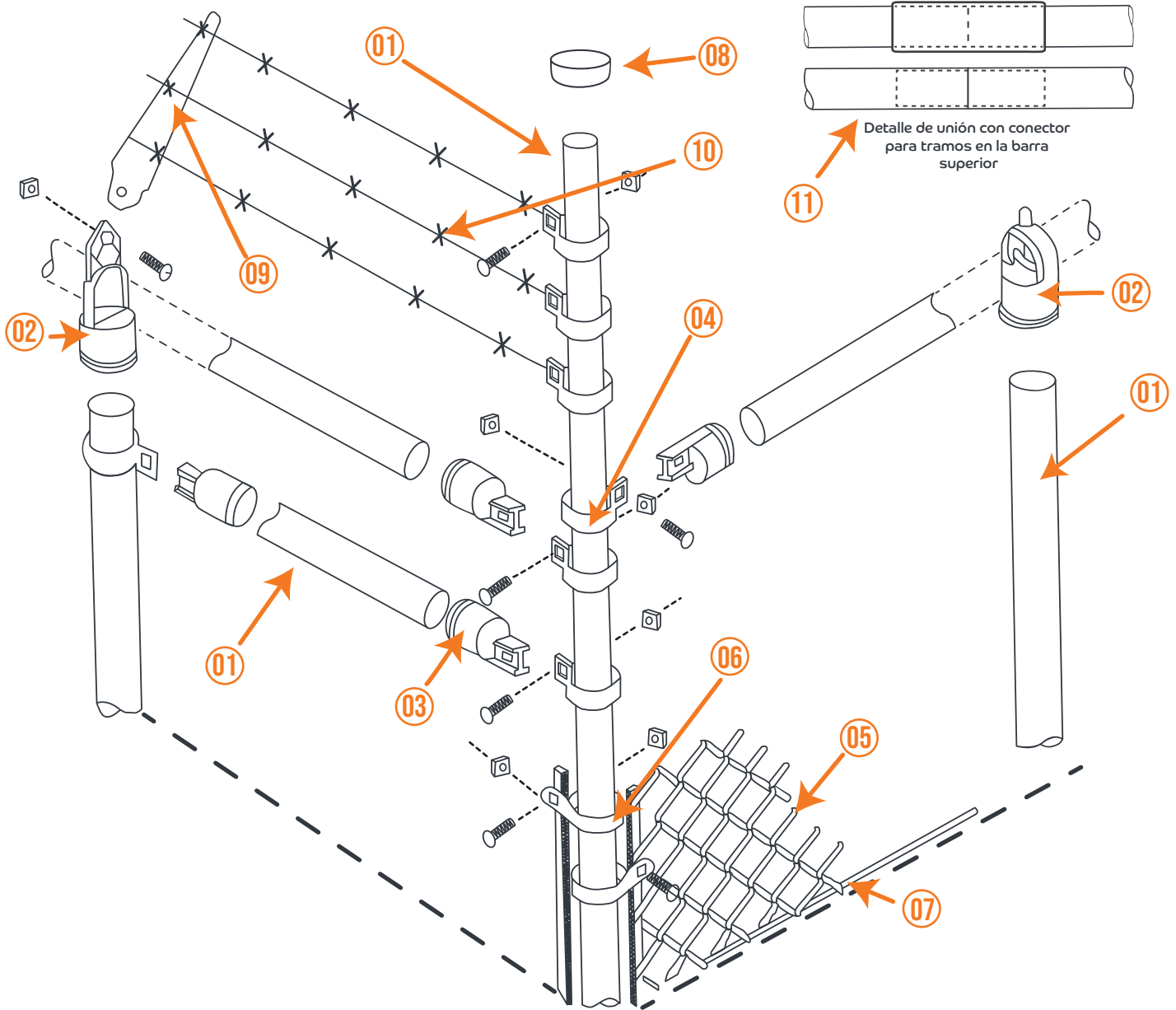

01 - TUBO CERQUERO

MEDIDAS: 1 1/2" -- 2" -- 2 1/2" -- 3"

02 - TAPÓN PUA O TAPÓN BARRA

ACCPT2 TAPÓN PUA 2" ACCPT2.5 TAPÓN PUA 2 1/2"

03 - COPLE

COPL SIMPLE COPL SIMPLE P/TUBO 2"

04 - ABRAZADERA DE ARRANQUE

ACCAA48 48 MM [2"] ACCAT60 60 MM [1 1/2"]

05 - MALLA CICLÓNICA

CALIBRES: - C/11 -- C/13

06 - ABRAZADERA DE TENSION

ACCAT38 38 MM ACCAT48 48 MM ACCAT62 60 MM

07 - ALAMBRE GALVANIZADO

MEDIDAS: #14

08 - TAPÓN SIMPLE

ACCTSTG1.5 1 1/2" ACCTSTG2 2" ACCTSTG2.5 2 1/2"

09 - ESPADA SENCILLA

ACCESPTG2 2" ACCESPTG2.5 2 1/2"

10 - ALAMBRE DE PÚAS

PESOS: 30KG, 34KG

11 - CONECTOR COPL UNIVERSAL P/ TUBO

COPLU 38 MM [1 1/2"]

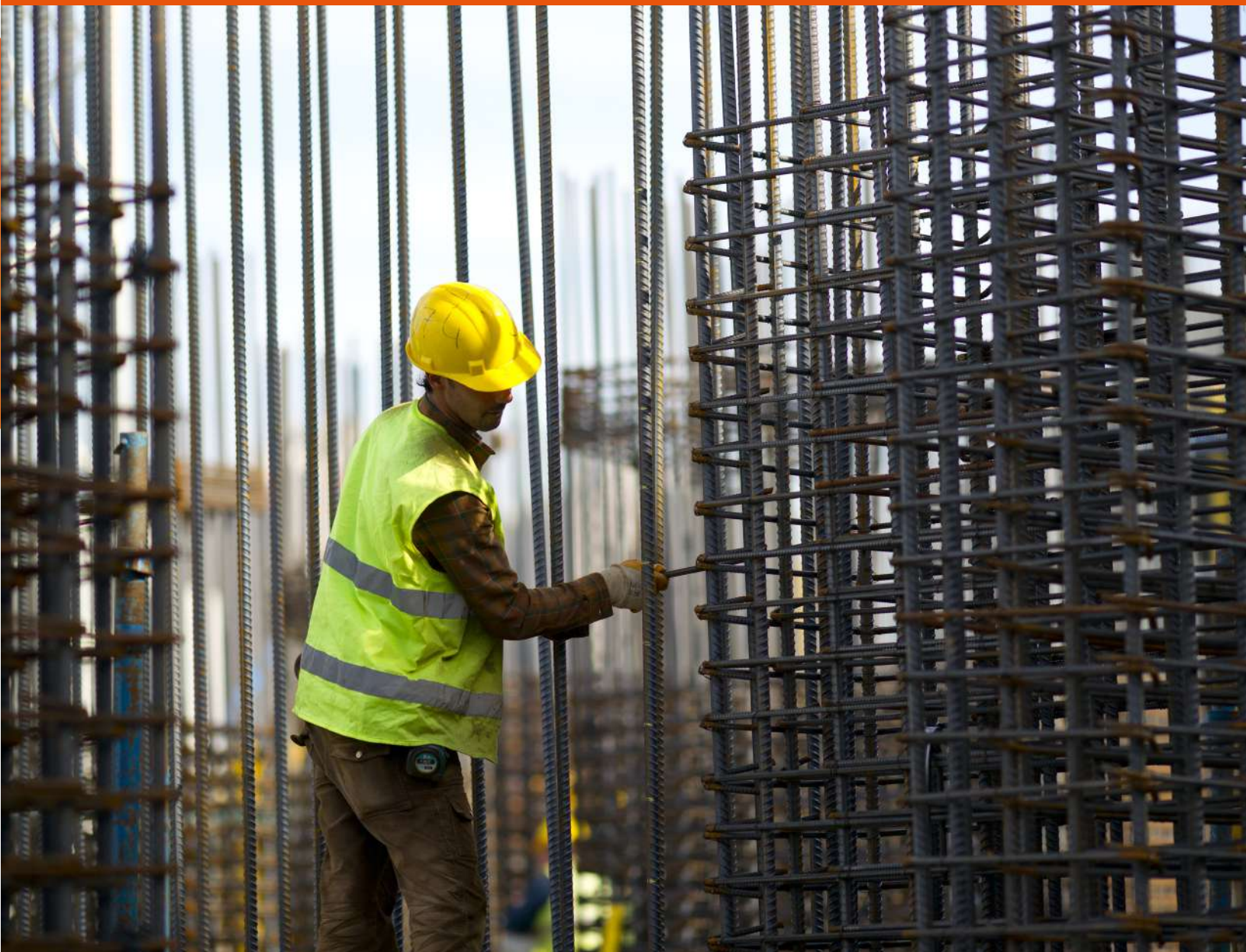

LÍNEA DE MATERIAL DE CONSTRUCCIÓN

ALAMBRÓN



ALAMBRON1

ALAMBRÓN

Alambrón de acero al carbón y sin tratamiento que se utiliza en la industria de la construcción para formar figuras de acero de refuerzo.

ALAMBRE RECOCIDO



RECOCIDO1

ALAMBRE RECOCIDO

Alambre de acero en acabado negro que se utiliza tanto en construcción como en diversos procesos industriales para múltiples tareas.

ARMEX



ARMEX12124	ARMEX 12 X 12-4
ARMEX15154	ARMEX 15 X 15-4
ARMEX15204	ARMEX 15 X 20-4
ARMEX15254	ARMEX 15 X 25-4
ARMEX15304	ARMEX 15 X 30-4

Castillo de acero, útil para reforzar elementos de concreto, confinar muros y distribuir la fuerza de los techos.

SONO TUBOS



SONO TUBOS	
CLAVE	MEDIDA
SONO-TUB15	SONO TUBO # 15 PZA.
SONO-TUB20	SONO TUBO # 20 PZA.
SONO-TUB25	SONO TUBO # 25 PZA
SONO-TUB30	SONO TUBO # 30 PZA
SONO-TUB35	SONO TUBO # 35 PZA
SONO-TUB40	SONO TUBO # 40 PZA

MALLA ELECTROSOLDADA



MALLAELEC66-10

MALLA ELECTROSOLDADA 66-1010 2.50X40

MALLAELEC66-66

MALLA ELECTROSOLDADA 66-66 2.50X40

VARILLA CORRUGADA



VARILLA CORRUGADA				
PULG	MM	VARILLA NO.	KG/ML	PZ x TON
3/8	9.50	3	0.56	150
1/2	12.70	4	0.99	84
5/8	15.90	5	1.55	53
3/4	19.10	6	2.24	37
1	25.40	8	3.97	21
1 1/4	31.80	10	6.23	13
1 1/2	38.10	12	8.94	9

ALAMBRE GALVANIZADO



ALAMBRE GALVANIZADO					
CLAVE	CALIBRE	DIÁMETRO (IN)	DIÁMETRO (MM)	RENDIMIENTO (M/ KG)	PESO
ALAMGAL008	8	0.162	4.115	4.115	100
ALAMGAL010	10	0.135	3.429	3.429	100
ALAMGAL012	12	0.105	2.68	2.68	100
ALAMGAL014	14	0.08	2.032	2.032	100
ALAMGAL016	16	0.062	1.588	1.588	25
ALAMGAL018	18	0.047	1.207	1.207	60-80
ALAMGAL020	20	0.033	0.84	0.84	30-40

Alambre de acero al carbono y galvanizado con recubrimiento de zinc. Diferentes calibres.

ALAMBRE GALVANIZADO SUAVE



ALAMBRE GALVANIZADO SUAVE DE 1KG				
CLAVE	CALIBRE	DIÁMETRO (IN)	DIÁMETRO (MM)	RENDIMIENTO (M/KG)
44465	12.5	0.099	2.515	25.7
44466	14.5	0.076	1.93	43.5
44467	16	0.062	1.588	64.4
44468	18	0.047	1.207	111.4
44469	20	0.035	0.884	207.6
44470	22	0.029	0.726	307.4

Alambre de acero con acabado galvanizado, se utiliza para amarres en mallas.

CLAVOS



CLAVOS			
MEDIDAS			
2	2 1/2	3	4

CEMENTO GRIS PORTLAND HOLCIM



CEMENTO	
CEMGRIS50K	CEMENTO GRIS HOLCIM vBULTO (50 KG.)

Bulto de cemento gris Portland Holcim de 50kg. Ideal para la construcción de todo tipo de obra y para la elaboración de elementos de concreto.

MORTERO PORTLAND HOLCIM



MORTERO	
MORMA50K	MORTERO MAESTRO (50KG.)

El mortero Holcim Maestro es un producto especialmente diseñado para elaborar trabajos de albañilería bien hechos y más durables.

USO: Aplanado de muros, junteo de elementos de mampostería como bloques, ladrillos y tabicones. Base para empedraros, entortados para pendientes y renivelaciones, entre otros.

CEMENTO GRIS CEMEX TOLTECA



CEMENTO	
CEMGRISTOL	CEMENTO GRIS TOLTECA BULTO (50 KG.)

Bulto de cemento gris Cemex Tolteca de 50kg. Ideal para la construcción de todo tipo de obra y para la elaboración de elementos de concreto.

MORTERO CEMEX TOLTECA



MORTERO	
	MORTERO MAESTRO (50KG.)

El mortero Cemex Tolteca Maestro es un producto especialmente diseñado para elaborar trabajos de albañilería bien hechos y más durables.



**LÍNEA DE
ACERO
ESTRUCTURAL**

CANALES C.P.S

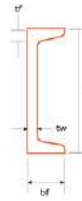

CANALES C.P.S									
PERALTE		PESO		PATÍN				ALMA	
d				ANCHO (BF)		ESPESOR(TF)		ESPESOR (TW)	
PULG.	MM.	KG./M.	KG X PIEZA	PULG.	MM.	PULG.	MM.	PULG.	MM.
3	76.20	5.210	31.78	1.372	34.85	0.273	6.93	0.13	3.35
		6.100	37.21	1.410	35.81	0.273	6.93	0.170	4.32
4	101.60	6.700	40.87	1.584	40.23	0.296	7.52	0.13	3.18
		8.040	45.05	1.584	40.23	0.296	7.52	0.184	4.67
5	127.00	9.970	60.82	1.750	44.45	0.320	8.13	0.19	4.83
6	152.40	12.200	74.42	1.920	48.77	0.343	8.71	0.20	5.08
		15.650	95.50	2.034	51.66	0.343	8.71	0.314	7.98
		19.350	118.04	2.157	54.79	0.343	8.71	0.437	11.10
8	203.20	17.200	104.92	2.260	57.40	0.390	9.91	0.22	5.59
		20.460	124.80	2.343	59.51	0.390	9.91	0.303	7.70
		27.900	170.19	2.527	64.19	0.390	9.91	0.487	12.37
10	254.000	22.760	138.84	2.600	66.04	0.436	11.07	0.24	6.10
		29.800	181.53	2.739	69.57	0.436	11.07	0.379	9.63
		37.200	226.92	2.886	73.30	0.436	11.07	0.526	13.36
		44.640	272.30	3.033	77.04	0.436	11.07	0.673	17.09
12	304.80	30.800	187.88	2.942	74.73	0.501	12.73	0.28	7.16
		37.200	226.92	3.047	77.39	0.501	12.73	0.387	9.83
		44.640	272.30	3.170	80.52	0.501	12.73	0.510	12.95
15	381.00	50.450	307.75	3.400	86.36	0.650	16.51	0.40	10.16
		59.530	363.13	3.520	89.41	0.650	16.51	0.520	13.21

H.S.S.



H.S.S.						
CUADRADO	RECTANGULAR	PESO EN KG/MTO				
PULGADAS		3/16	1/4	5/16	3/8	1/2
4X4	5X3	14.02	1.17	22.07	57.70	23.19
	6X2					
4 1/2 X 4 1/2	5 X 4	15.92	20.70	25.24	29.50	37.25
	6 X 3					
	7 X 2					
5 X 5	6 X 4	17.81	23.25	28.39	33.29	42.31
	7 X 3					
	8 X 2					
5 1/2 X 5 1/2	6 X 5	19.72	25.77	31.56	37.10	
	7 X 4					
	8 X 3					
6 X 6	7 X 5	21.62	28.30	34.73	40.89	52.44
	8 X 4					
	9 X 3					
	10 X 2					
7 X 7	8 X 6	25.42	33.36	41.06	48.48	62.58
	9 X 5					
	10 X 4					
	12 X 2					
7 1/2 X 7 1/2	8 X 6	27.31	35.89	44.23	52.28	67.64
	9 X 5					
	10 X 4					
	12 X 2					
8 X 8	9 X 7	29.21	38.42	47.38	56.09	72.70
	10 X 6					
	12 X 4					
9 X 9	10 X 8	33.01	43.50	53.72	63.68	82.83
	12 X 6					
	16 X 4					
10 X 10	12 X 8	36.80	48.50	60.05	71.28	92.95
	14 X 6					
	16 X 4					
12 X 12	14 X 10	44.41	58.68	72.71	86.46	113.20
	16 X 8					
	18 X 6					
	20 X 4					
14 X 14	16 X 12			85.36	101.66	133.46
	20 X 8					
16 X 16	20 X 12			98.03	116.85	153.73

VIGA IPS (AMERICANA)

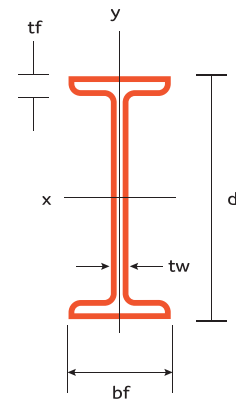

VIGAS IPS (AMERICANA)							
PERALTE		PESO		PATÍN		ANCHO DEL ALMA	
D		KG/MT	KG x PZA	ANCHO (BF)	ESPESOR (TF)	ESPESOR (TW)	
PULG	MM			PULG	MM	PULG	MM
3	76.2	8.48	51.73	2.33	59.18	0.17	4.3
4	101.6	11.46	69.91	2.66	67.64	0.19	4.9
5	127	14.88	90.77	3.00	76.3	0.21	5.4
6	152.4	18.6	113	3.33	84.63	0.23	5.9
8	203.2	27.38	167.02	4.00	101.63	0.27	6.9

VIGAS IPR (12.20m)

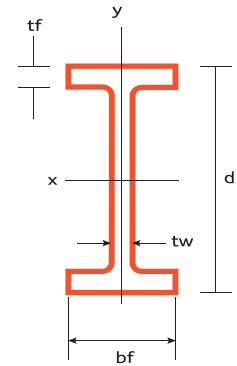
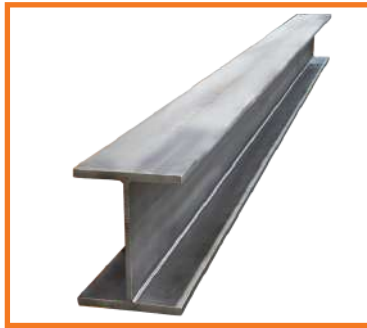

VIGAS IPR (12.20m)											
NOMINAL		PESO		PERALTE		PATÍN				ALMA	
				D		ANCHO (BF)		ESPESOR (TF)		ESPESOR (TW)	
pulg (d x bf)	mm (d x bf)	kg./m.	kg. X pieza (12.20m)	pulg.	mm.	pulg.	mm.	pulg.	mm.	pulg.	mm.
4 x 4	1.1.6 x 101.6	19.30	117.73	4.16	106	4.06	103	0.35	8.8	0.28	7.11
6 x 4	152.4 x 101.6	12.70	154.94	5.83	148	3.94	100	0.20	5.0	0.17	4.3
		13.40	163.48	5.9	150	3.94	100	0.22	5.5	0.17	4.3
		17.90	218.38	6.03	153	4.00	102	0.28	7.1	0.23	5.8
			290.36	6.28	160	4.03	102	0.41	10.3	0.26	6.6
6 x 6	152.4 x 152.4	22.30	272.06	5.99	152	5.99	152	0.26	6.6	0.23	5.8
		29.70	362.34	6.2	157	6.02	153	0.37	9.3	0.26	6.6
		37.20	453.84	6.38	162	6.08	154	0.46	11.6	0.32	8.1
8 x 4	203.2 x 101.6	14.90	181.78	7.89	200	3.94	100	0.21	5.2	0.17	4.3
		19.40	236.68	7.99	203	4	102	0.26	6.5	0.23	5.8
			273.28	8.11	206	4.02	102	0.32	8.0	0.25	6.2
8 x 5 1/4	203.2 x 133.4	26.90	328.18	8.14	207	5.25	133	0.33	8.4	0.23	5.8
		31.30	381.86	8.28	210	5.27	134	0.40	10.2	0.25	6.4
8 x 6 1/2	203.2 x 165.1	35.70	435.54	7.93	201	6.5	165	0.40	10.2	0.25	6.2
		41.70	508.74	8.06	205	6.54	166	0.47	11.8	0.29	7.2
8 x 8	203.2 x 203.20	46.20	563.64	8.00	203	8.00	203	0.44	11.0	0.29	7.2
		52.10	635.62	8.12	206	8.02	204	0.5	12.6	0.31	7.9
		59.60	727.20	8.25	210	8.07	205	0.56	14.2	0.36	9.1
		71.40	435.54	8.50	216	8.11	206	0.69	17.4	0.4	10.2
		86.30	526.43	8.75	222	8.22	209	0.81	20.6	0.51	13
10 x 4	254 x 101.6	17.90	218.38	9.87	251	3.96	101	0.21	5.3	0.19	4.8
		22.40	272.83	9.99	254	4.00	102	0.27	6.9	0.23	5.8
		25.50	311.10	10.11	257	4.01	102	0.33	8.4	0.24	6.1
		28.30	345.26	10.24	260	4.02	102	0.4	10.0	0.25	6.4
10 x 5-3/4	254 x 146	32.80	400.16	10.17	258	5.75	146	0.36	9.1	0.24	6.1
		38.70	472.14	10.33	262	5.77	147	0.44	11.2	0.26	6.6
		44.70	545.34	10.47	266	5.81	148	0.51	13.0	0.3	7.6
10 x 8	254 x 203.2	49.20	600.24	9.73	247	7.96	202	0.44	11.0	0.29	7.4
		58.31	708.82	9.92	252	7.99	203	0.53	13.5	0.32	8
		67.00	815.40	10.10	257	8.02	204	0.62	15.7	0.65	8.9

VIGAS IPR (12.20m)

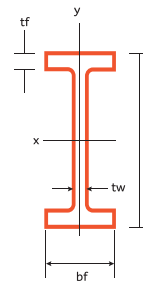
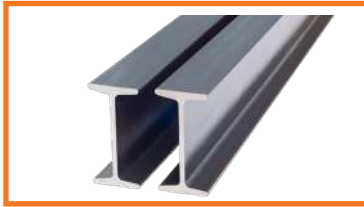

VIGAS IPR (12.20m)											
NOMINAL		PESO		PERALTE		PATÍN			ALMA		
				D		ANCHO (BF)		ESPELOR (TF)		ESPELOR (TW)	
pulg (d x bf)	mm (d x bf)	kg./m.	kg. X pieza (12.20m)	pulg.	mm.	pulg.	mm.	pulg.	mm.	pulg.	mm.
10 x 10	254 x 254	72.90	889.38	9.98	253	10.00	254	0.56	14.2	0.34	8.6
		80.40	980.88	10.09	256	10.03	255	0.62	15.6	0.37	9.4
		89.40	1090.68	10.22	260	10.08	256	0.68	17.3	0.42	10.37
		101.10	1233.42	10.40	264	10.13	257	0.77	19.6	0.47	11.9
		114.70	1400.00	10.60	269	10.19	259	0.87	22.1	0.53	13.5
		130.94	1597.46	10.84	275	10.265	261	0.99	25.1	0.605	15.4
		148.80	1815.36	11.10	282	10.34	263	1.12	28.4	0.68	17.3
		166.65	2033.13	11.36	289	10.415	265	1.25	31.8	0.755	19.2
12 x 4	304.8 x 101.6	20.90	255.00	11.91	303	3.97	101	0.23	5.7	0.2	5.1
		23.80	290.36	11.99	305	3.99	101	0.27	6.7	0.22	5.6
		28.30	345.26	12.16	309	4.01	102	0.35	8.9	0.24	6
		32.80	400.16	12.31	313	4.03	102	0.43	10.8	0.26	6.6
12 x 6-1/2	304.8 x 165.1	38.70	472.14	12.22	310	6.49	165	0.38	9.7	0.23	5.8
		44.70	545.34	12.34	313	6.52	166	0.44	11.2	0.26	6.6
		52.20	636.84	12.5	318	6.56	167	0.52	13.2	0.3	7.6
12 x 8	304.8 x 203.2	59.60	727.12	11.94	303	8.01	203	0.52	13.1	0.3	7.5
		67.10	818.62	12.06	306	8.05	204	0.58	14.6	0.34	8.5
		74.50	908.90	12.19	310	8.08	205	0.64	16.3	0.37	9.4
12 x 10	304.8 x 254	78.90	962.58	12.06	306	10.00	254	0.58	14.6	0.35	8.8
		86.30	1052.86	12.19	310	10.01	254	0.64	16.3	0.36	9.1
12 x 12	304.8 x 604.8	96.70	1180.90	12.12	308	12.00	305	0.61	15.4	0.39	9.9
		107.10	1306.62	12.25	311	12.04	306	0.67	17	0.43	10.9
		117.50	1433.50	12.38	314	125.08	307	0.74	18.7	0.47	11.9
		129.50	1579.90	12.53	318	12.13	308	0.81	20.6	0.515	13.1
		142.90	1743.38	12.71	323	12.16	309	0.9	22.9	0.55	14
		157.72	1924.18	12.89	327	12.22	310	0.99	25.1	0.61	15.5
		202.60	2472.00	13.41	341	12.40	315	1.25	31.8	0.79	20.1
		226.17	2759.27	13.71	348	12.48	317	1.4	35.6	0.87	22.1
		252.99	3086.48	14.03	356	12.57	319	1.56	39.6	0.96	24.4
14 x 5	355.6 x 127	32.70	400.00	13.74	349	5.00	127	0.34	8.5	0.23	5.8
		38.70	472.14	13.91	353	5.03	128	0.42	10.7	0.26	6.5
14 x 6 3/4	355.6 x 127	44.70	545.34	13.84	352	6.73	171	0.39	9.8	0.27	6.9
		50.70	618.54	13.98	355	6.75	171	0.46	11.6	0.29	7.2
		56.60	690.52	14.1	358	6.77	172	0.52	13.1	0.31	7.9

VIGAS IPR (12.20m)

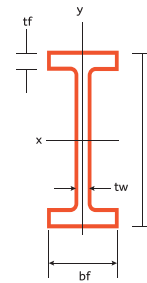
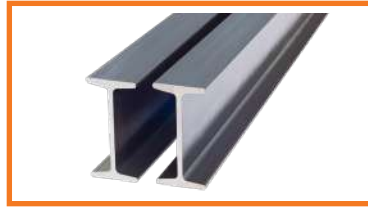

VIGAS IPR (12.20m)											
NOMINAL		PESO		PERALTE		PATÍN				ALMA	
				D	ANCHO (BF)	ESPESOR (TF)		ESPESOR (TW)			
pulg (d x bf)	mm (d x bf)	kg./m.	kg. X pieza (12.20m)	pulg.	mm.	pulg.	mm.	pulg.	mm.	pulg.	mm.
14 x 8	355.6 x 203.2	64.10	782.02	13.66	347	8.00	203	0.53	13.5	0.31	7.7
		71.50	872.30	13.79	350	8.03	204	0.6	15.1	0.34	8.6
		79.00	963.80	13.92	354	8.06	205	0.66	16.8	0.37	9.4
14 x 10	355.6 x 203.2	90.80	1107.70	13.89	353	10.00	254	0.65	16.4	0.38	9.5
		101.30	1235.80	14.04	357	10.04	255	0.72	18.36	0.42	10.5
		110.26	1345.10	14.17	360	10.07	256	0.79	19.9	0.45	11.4
		122.18	1490.50	14.31	363	10.13	257	0.855	21.7	0.51	13
14 x 14 1/2	355.6 x 368.3	134.10	1636.00	14.02	356	14.52	369	0.74	18	0.44	11.02
		147.50	1799.50	14.16	360	14.57	370	0.78	19.8	0.49	12.3
		162.40	1981.20	14.32	364	14.61	371	0.86	21.8	0.53	13.3
		178.80	2182.36	14.48	368	14.67	373	0.94	23.9	0.59	15
		196.70	2399.70	14.66	372	14.73	374	1.03	26.2	0.65	16.4
14 x 16	355.6 x 406.4	215.80	2632.76	14.78	375	15.50	394	1.09	27.7	0.68	17.36
		236.60	2886.52	14.98	380	15.57	395	1.19	30.2	0.75	18.9
		261.90	3195.18	15.22	387	15.65	398	1.31	33.3	0.83	21.1
		287.20	3503.84	15.48	393	15.71	399	1.44	36.6	0.89	22.6
		313.96	3830.3	15.72	399	15.80	401	1.56	39.6	0.98	24.9
		382.41	4665.4	16.38	416	16.00	406	1.89	48	1.175	29.8
16 x 5 1/2	406.4 x 139.7	38.70	472.14	15.69	399	5.50	140	0.65	8.8	0.25	6.4
		46.20	563.64	15.88	403	5.53	140	0.44	11.2	0.28	7
16 x 7	406.4 x 177.8	53.60	690.52	15.86	403	6.99	177	0.43	10.9	0.30	7.5
		59.60	727.12	16.01	407	7.00	178	0.51	12.8	0.31	7.7
		67.10	818.62	16.13	410	7.04	179	0.57	14	0.35	8.8
		74.50	908.90	16.26	413	7.07	180	0.63	16.00	0.38	9.7
		84.90	1036.14	16.43	417	7.12	181	0.72	18.2	0.43	10.9
16 x 10 1/4	406.4 x 254	99.83	1217.93	16.33	415	10.24	260	0.67	16.9	0.40	10
		114.70	1399.34	16.52	420	10.30	261	0.76	19.36	0.46	11.6
		132.60	1617.72	16.75	425	10.37	263	0.88	22.2	0.53	13.3
		149.00	1817.80	16.97	431	10.42	265	0.98	25	0.58	14.9
18 x 7 1/2	457.2 x 190.5	74.50	908.90	17.99	457	7.50	190	0.57	14.5	0.36	9
		85.00	1000.4	18.11	460	7.53	191	0.63	16	0.39	9.9
		89.40	1090.68	18.24	463	7.56	192	0.7	17.7	0.42	10.5
		96.90	1182.18	18.35	466	7.59	193	0.75	19.1	0.45	11.4
		105.60	1288.32	18.47	469	7.64	194	0.81	20.6	0.50	12.6

VIGAS IPR (12.20m)

VIGAS IPR (12.20m)											
NOMINAL		PESO		PERALTE		PATÍN				ALMA	
				D		ANCHO (BF)		ESPESOR (TF)		ESPESOR (TW)	
pulg. (d x bf)	mm (d x bf)	kg./m.	kg. X pieza (12.20m)	pulg.	mm.	pulg.	mm.	pulg.	mm.	pulg.	mm.
18 x 11	457.2 x 279.4	113.20	1381.04	18.21	463	11.04	280	0.68	17.3	0.43	10.8
		128.10	1565.82	18.39	467	11.09	282	0.77	19.6	0.48	12.2
		144.30	1760.46	18.59	472	11.15	283	0.87	22.1	0.54	13.6
		157.70	1923.94	18.73	476	11.20	284	0.94	23.9	0.59	15
		177.63	2163.06	18.97	482	11.27	286	1.06	26.9	0.66	16.6
		193.44	1179.98	19.25	489	11.16	283	1.2	30.5	0.67	17
		213.00	2597.38	19.49	495	11.22	285	1.32	33.5	0.73	18.5
		235.00	2867.00	19.72	501	11.30	287	1.44	36.6	0.81	20.6
		260.40	3176.88	20.04	509	11.37	289	1.59	40.4	0.89	22.6
		285.69	3485.42	30.32	517	11.45	291	1.75	44.4	0.96	24.4
21 x 6 1/2	533.4 x 165.1	65.6	800.32	20.66	525	6.5	165	0.45	11.4	0.35	8.9
		74.5	908.9	20.83	529	6.53	166	0.54	13.6	0.38	9.7
		84.9	1035.78	21.06	535	6.56	166	0.65	16.5	0.41	10.3
21 x 8 1/4	533.4 x 209.5	92.4	1127.28	20.99	533	8.24	209	0.62	15.6	0.4	10.2
		108.6	1324.92	21.24	539	8.295	211	0.74	18.8	0.455	11.6
		123.5	1506.7	24.43	544	8.355	212	0.835	21.2	0.515	13.1
		101.3	1235.86	21.13	537	8.27	210	0.69	17.4	0.43	10.9
		138.4	1688.48	21.62	549	8.42	214	0.93	23.6	0.58	14.7
21 x 12- 1/4	533.4 x 311.15	150.30	1833.66	21.36	543	12.29	312	0.8	20.3	0.5	12.7
		165.20	2015.44	21.51	546	12.37	313	0.88	22.2	0.55	14
		181.50	2214.30	21.68	551	12.39	315	0.96	24.4	0.6	15.2
21 x 12- 1/2	533.4 x 317.5	218.00	2659.60	22.06	560	12.51	318	1.15	29.2	0.72	18.3
24 x 9	609.6 x 228.6	101.30	1235.86	23.73	603	8.97	228	0.59	14.9	0.42	10.5
		113.24	1381.53	23.93	608	8.99	228	0.68	17.3	0.44	11.2
		125.20	1527.44	24.1	612	9.02	229	0.77	19.6	0.47	11.9
		140.00	1708.00	24.31	617	9.07	230	0.88	22.2	0.52	13.1
		153.40	1871.48	24.53	623	9	229	0.98	24.9	0.55	14
27 x 10	685.8 x 254	125.20	1527.44	26.71	678	9.96	253	0.64	16.3	0.46	11.7
		140.00	1708.00	26.92	684	9.99	254	0.75	18.9	0.49	12.4
		151.80	1851.96	27.09	688	10.02	254	0.83	21.1	0.52	13.1
		169.80	2071.56	27.29	693	10.07	256	0.93	23.6	0.57	14.5
		191.95	2341.79	27.63	702	10.01	254	1.1	27.9	0.61	15.5
30 x 10 1/2	762 x 266.7	217.00	2071.56	27.38	695	13.965	355	0.975	24.8	0.605	15.4
		239.70	2924.34	27.59	701	14.02	356	1.08	27.4	0.66	16.8
		288.67	3521.77	28.11	714	14.035	356	1.34	34	0.75	19
		323.00	3940.60	28.43	722	14.115	359	1.5	38.1	0.83	21.1
		350.00	4270.00	28.66	728	14.19	360	1.64	40.9	0.91	23.2
		384.00	4684.80	28.98	736	14.27	362	1.77	45	0.98	24.9

VIGAS IPR (12.20m)

VIGAS IPR (12.20m)											
NOMINAL		PESO		PERALTE		PATÍN				ALMA	
				D		ANCHO (BF)		ESPESOR (TF)		ESPESOR (TW)	
pulg (d x bf)	mm (d x bf)	kg./m.	kg. X pieza (12.20m)	pulg.	mm.	pulg.	mm.	pulg.	mm.	pulg.	mm.
30 x15	762 x 381	257.42	3140.52	30.44	773	14.985	381	1.065	27.1	0.655	16.6
		313.96	3830.31	30.94	786	15.105	384	1.315	33.4	0.775	19.7
33 x 11-1/2	838.2 x 292.10	175.80	2144.76	32.86	835	11.48	292	0.74	18.8	0.55	14
		193.40	2359.48	33.09	840	11.51	292	0.86	21.7	0.58	14.7
		209.80	2559.56	33.3	846	11.54	293	0.96	24.4	0.61	15.4
		226.20	2759.64	33.49	851	11.57	294	1.06	26.8	0.64	16.1
		251.50	3068.30	33.82	859	11.5	292	1.22	31	0.67	17
33 x 15-3/4	383.2 x 400.05	328.88	4012.34	33.93	862	15.805	401	1.275	32.4	0.775	19.7
36 x 12	914.4 x 304.8	200.90	2450.98	35.55	903	11.95	304	0.79	20.1	0.6	15.2
		223.20	2723.04	35.85	911	11.98	304	0.94	23.9	0.63	15.9
		238.10	2904.82	36.01	915	12	305	1.02	25.9	0.65	16.5
		252.99	3086.48	36.17	919	12.03	306	1.1	27.9	0.68	17.3
		270.85	3304.37	36.33	923	12.075	307	1.18	30	0.725	18.4
		288.70	3522.14	36.49	927	12.115	308	1.26	32	0.765	19.4
		312.51	3812.62	36.69	932	12.18	309	1.36	34.5	0.83	21.1
		345.25	4212.05	37.12	943	12.12	308	1.57	39.9	0.87	22.1
40 x 12	1016 x 304.8	221.74	2705.23	38.2	970	11.81	300	0.83	21.1	0.63	16
		248.52	3031.94	38.59	980	11.81	300	1.025	26	0.65	16.5
		272.33	3322.43	38.98	990	11.81	300	1.2	31	0.65	16.5
		314.00	3830.80	39.37	1000	11.81	300	1.415	35.9	0.75	19.31
		349.72	4266.58	39.69	1008	11.89	302	1.575	40	0.83	21.1
		392.87	4793.01	40	1016	11.93	303	1.73	43.9	0.96	24.4



**LÍNEA DE
ACERO DE
HERRERÍA**

ÁNGULOS

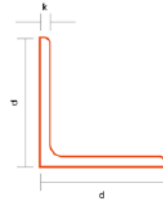

ÁNGULOS					
PULG		MM.		PESO	
ESPESOR	ANCHO	ESPESOR	ANCHO	KG./M.	KG X PIEZA(6.10)
(K)	(BF)	(K)	(BF)		
CAL.12(.109")	1	2.77X	25.4	1.04	6.344
	1 1/4		31.75	1.32	8.052
	1 1/2		38.1	1.59	9.700
1/8X	3/4	3.18X	19.05	0.88	5.370
	1		25.4	1.19	7.260
	1 1/4		31.75	1.50	9.150
	1 1/2		38.1	1.83	11.170
	2		50.8	2.46	15.010
3/16X	1	4.76X	25.4	1.73	10.560
	1 1/4		31.75	2.20	13.420
	1 1/2		38.1	2.68	16.350
	2		50.8	3.63	22.150
	2 1/2		63.5	4.60	28.060
	3		76.2	5.97	36.420
1/4X	1	6.35X	25.4	2.23	13.580
	1 1/4		31.75	2.86	17.450
	1 1/2		38.1	3.49	21.290
	2		50.8	4.75	29.000
	2 1/2		63.5	6.10	37.210
	3		76.2	7.29	44.470
	3 1/2		88.9	8.68	53.000
	4		101.6	9.90	60.390

ÁNGULOS

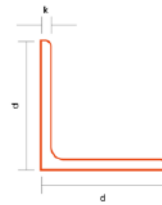

ÁNGULOS					
PULG		MM.		PESO	
ESPEJOR	ANCHO	ESPEJOR	ANCHO		
(K)	(BF)	(K)	(BF)	KG./M.	KG X PIEZA(6.10)
5/16X	2	7.94X	50.8	5.84	35.600
	2 1/2		63.5	7.44	45.500
	3		76.2	9.08	55.390
	3 1/2		88.9	10.81	66.000
	4		101.6	12.20	74.420
	5		127	15.24	93.000
3/8 X	2	9.53X	50.8	6.99	42.500
	2 1/2		63.5	8.79	53.620
	3		76.2	10.72	65.400
	4		101.6	14.60	89.060
	5		127	18.60	113.500
	6		152.4	22.27	135.240
7/16X	4	11.1X	102	16.8	102.48
	6		152	25.6	156.16
	5		127	21.3	129.93
3/4 X	5	19.05X	127	35.12	214.232
7/8 X	6	22.23X	152	49.26	300.486
	8		203	66.97	408.517
1X	8	25.4X	203	75.9	462.99
1- 1/8X	8	28.56X	203	84.68	516.548
1/2X	3	12.70X	76.2	13.99	85.340
	4		101.6	19.05	116.000
	5		127	24.11	147.071
	6		152.4	29.17	177.94
	8		203	39.3	239.73
5/8X	4	15.88X	101.6	23.36	142
	6		152.4	36.01	219.67
	8		203.2	48.66	296.826
3/4 X	6	19.05X	152.4	42.71	260.54
	8		203.2	57.89	353.129
1 X	6	25.4X	152.4	55.66	339.526

CARAMELO



CARAMELO			
Clave	Medida	Peso x pieza (kg.)	Largo (m)
CAR012	CARAMELO 1/2	7	6.0
CAR019	CARAMELO 3/4	17.5	6.0
CAR010	CARAMELO 3/8	4.5	6.0
CAR015	CARAMELO 5/8	12.12	6.0

CUADRADOS Y REDONDOS



CUADRADOS Y REDONDOS								
MEDIDAS			PESO					
PULG.	MILÉSIMA	MM.	REDONDOS		CUADRADOS		CUADRADO CARAMELO	
			KG./M.	KG X PIEZA	KG./M.	KG X PIEZA	KG./M.	KG X PIEZA
12 MM.	0.472	12.00			1.14	6.95	1.14	6.95
3/8	0.375	9.53	0.56	3.42	0.71	4.50	0.71	4.50
1/2	0.500	12.70	0.99	6.04	1.26	7.73	1.26	7.73
5/8	0.625	15.88	1.55	9.46	1.98	12.12	1.98	12.12
3/4	0.750	19.05	2.24	13.66	2.85	17.40	2.85	17.40
7/8	0.875	22.23	3.04	18.54				
1	1.000	25.40	3.97	24.22	5.06	30.90		
1 1/8	1.125	28.58	5.03	30.68				
1 1/4	1.250	31.75	6.21	37.88	7.91	48.27		
1 3/8	1.375	34.93	7.51	45.81				
1 1/2	1.500	38.10	8.94	54.53	11.38	69.50		
1 3/4	1.750	44.45	12.17	74.24				
1 7/8	1.875	47.63	13.97	85.22				
2	2.000	50.80	15.90	96.99	20.24	123.58		
2 1/4	2.250	57.15	20.12	122.73				
2 1/2	2.500	63.50	24.84	151.52	31.62	193.09		
3	3.000	76.20	35.76	218.14	45.54	277.79		

PTR Y PERFILES RECTANGULARES



PTR Y PERFILES RECTANGULARES					
CÓDIGO	DIAM IN	CALIBRE	KGXPIEZA	LONGITUD M	KGXMETRO
R-100	1.0X0.5	20	3.20	6.0	0.5
		18	4.30	6.0	0.71
		16	5.04	6.0	0.84
		14	6.12	6.0	1.2
R-125	1.25X0.75	20	4.51	6.0	0.75
		18	5.93	6.0	0.98
		16	6.84	6.0	1.14
		14	8.40	6.0	1.40
R-155	1.5X0.50	20	4.20	6.0	0.7
		18	5.52	6.0	0.92
		14	8.40	6.0	1.4
R-150	1.5X0.75	16	7.50	6.0	1.25
		14	9.12	6.0	1.52
		11	13.50	6.0	2.25
R-151	1.5X1.0	18	6.84	6.0	1.14
		16	8.40	6.0	1.4
		11	15.36	6.0	2.56
R-175	1.75X0.75	20	5.22	6.0	0.87
		18	6.84	6.0	1.14

PTR Y PERFILES RECTANGULARES					
CÓDIGO	DIAM IN	CALIBRE	KGXPIEZA	LONGITUD M	KGXMETRO
R-502	5.0X2.0	11	48.06	6.0	8.01
		3/16	74.05	6.1	12.14
		1/4	95.59	6.1	15.67
R-503	5.0X3.0	14	35.28	6.0	5.88
		11	55.38	6.0	9.23
		10	61.86	6.0	10.31
		3/16	85.64	6.1	14.04
		1/4	111.02	6.1	18.20
R-602	6.0X2.0	14	35.28	6.0	5.88
		11	55.38	6.0	9.23
		3/16	85.64	6.1	14.04
		1/4	111.02	6.1	18.20
R-603	6.0X3.0	11	62.64	6.0	10.44
		3/16	97.23	6.1	15.94
		1/4	126.51	6.1	20.74
R-604	6.0X4.0	11	69.90	6.0	11.65
		9	86.52	6.0	14.42
		3/16	108.89	6.1	17.85
		1/4	141.95	6.1	23.27
R-804	8.0X4.0	3/16	264.13	12.2	21.65
		1/4	345.87	12.2	28.35

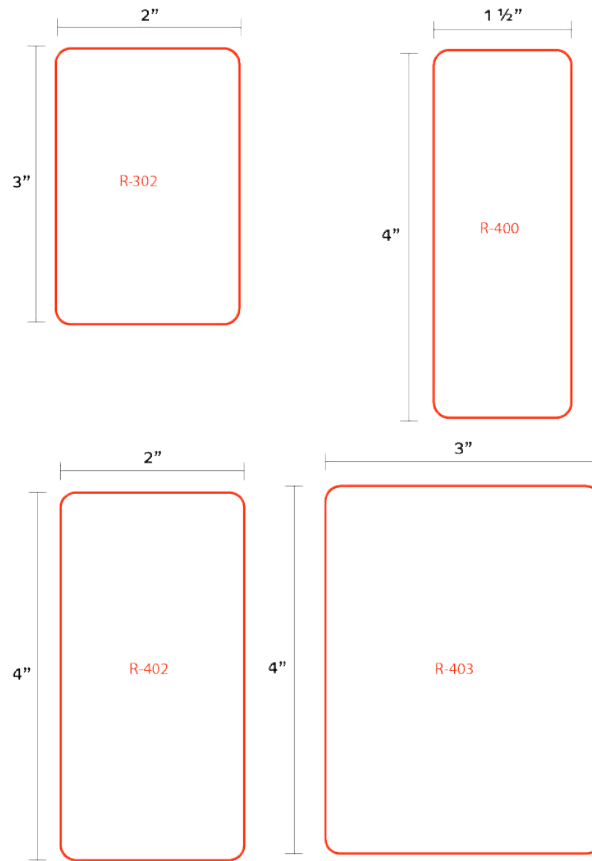

PTR Y PERFILES RECTANGULARES

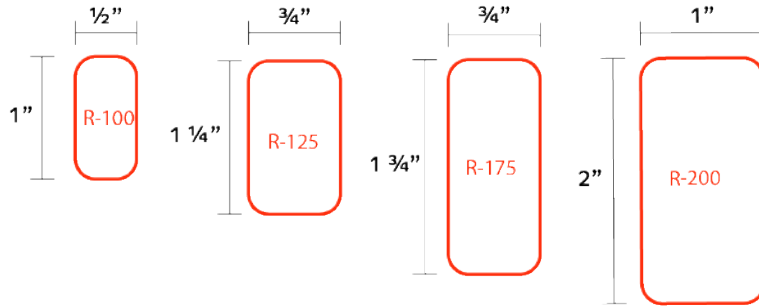

PTR Y PERFILES RECTANGULARES					
R-200	2.0X1.0	20	6.30	6.0	1.05
		18	8.28	6.0	1.38
		16	10.20	6.0	1.7
		1	12.54	6.0	2.09
		12	16.92	6.0	2.82
		11	18.96	6.0	3.16
R-225	2.25X0.75	20	6.30	6.0	1.05
		18	8.28	6.0	1.38
R-249	2.5X1.25	20	7.92	6.0	1.32
		18	10.44	6.0	1.74
		16	12.96	6.0	2.16
		14	15.96	6.0	2.66
		12	21.66	6.0	3.61
R-250	2.5X1.5	18	11.16	6.0	1.86
		14	17.04	6.0	2.84
		12	23.28	6.0	3.88
		11	26.28	6.0	4.38
R-275	2.75X1.00	12	21.66	6.0	3.61
		11	24.42	6.0	4.07
R-301	3.0X1.0	18	11.16	6.0	1.86
		16	13.86	6.0	2.31
		14	17.04	6.0	2.84
		11	26.28	6.0	4.38
		10	29.10	6.0	4.85
R-300	3.0X1.5	22	7.98	6.0	1.33
		20	9.60	6.0	1.6
		18	12.66	6.0	2.11

PTR Y PERFILES RECTANGULARES

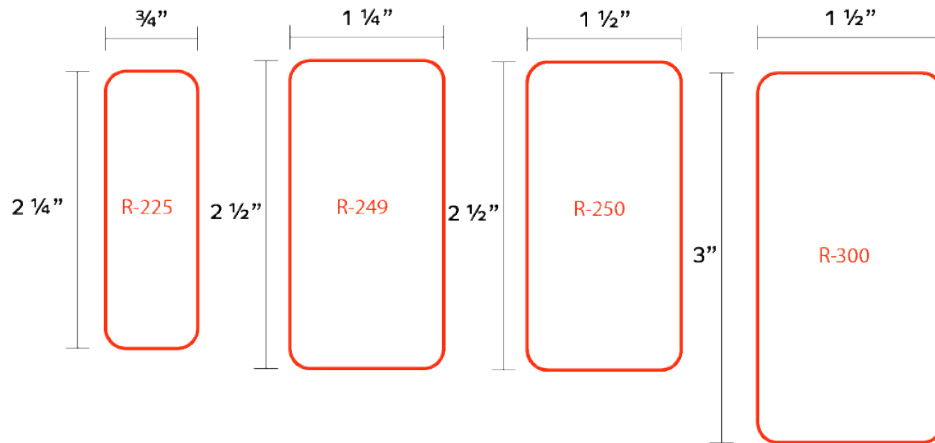

PTR Y PERFILES RECTANGULARES					
CÓDIGO	DIAM IN	CALIBRE	KGXPIEZA	LONGITUD M	KGXMETRO
R-302	3.0X2.0	16	17.46	6.0	2.91
		14	21.60	6.0	3.60
		12	29.64	6.0	4.94
		11	33.54	6.0	5.59
		10	37.32	6.0	6.22
		9	41.04	6.0	6.84
		3/16	50.87	6.1	8.34
		1/4	64.60	6.1	10.59
R-400	4.0X1.5	20	11.76	6.0	1.96
		18	15.54	6.0	2.59
		16	19.32	6.0	3.22
		14	23.88	6.0	3.98
R-402	4.0X2.0	14	26.16	6.0	4.36
		11	40.80	6.0	6.80
		10	45.48	6.0	7.58
		9	50.10	6.0	8.35
		3/16	62.46	6.1	10.24
		1/4	80.09	6.1	13.13
R-403	4.0X3.0	14	30.72	6.0	5.12
		11	48.06	6.0	8.01
		9	59.22	6.0	9.87
		3/16	74.05	6.1	12.14
		1/4	95.59	6.1	15.67

PERFILES PARA PUERTA

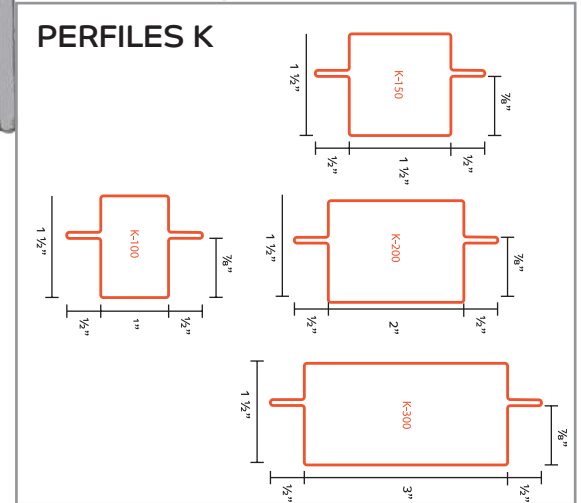
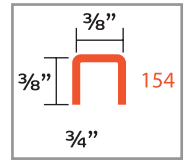
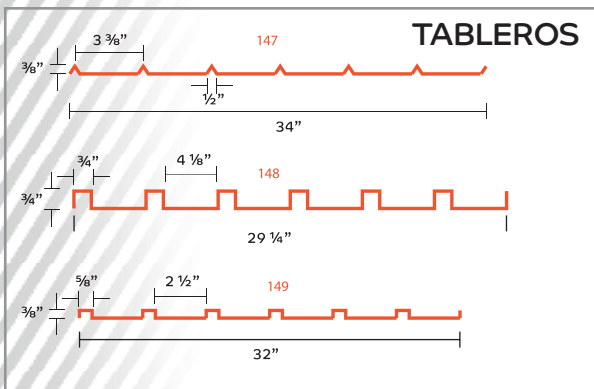
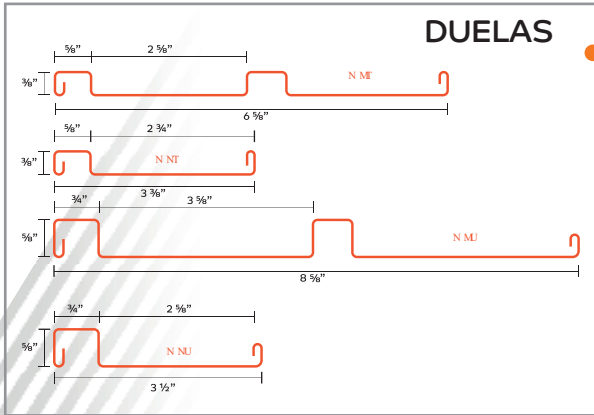
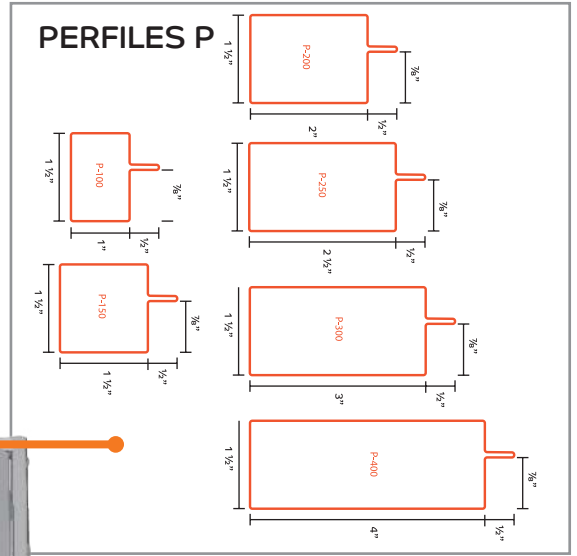
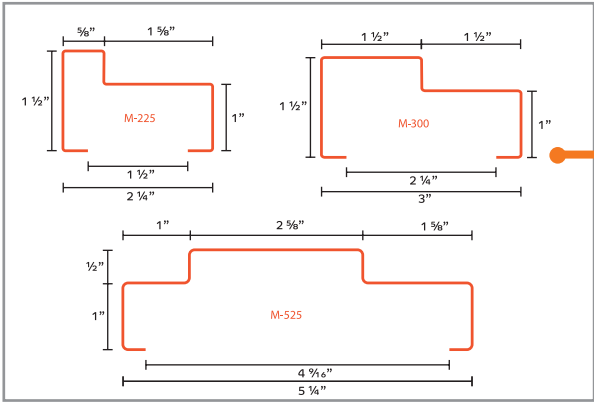

PERFILES PARA PUERTA					
CLAVE	CÓDIGO	CALIBRE	KG X PIEZA	KG X METRO	LONGITUD M
PERP154C20	154	20	1.11	0.18	6.0
PERP154C18		18	1.42	0.23	6.0
PERP155C20	155	20	1.50	0.25	6.0
PERP156C20	156	20	2.34	0.39	6.0
PERP221C20	M-221	20	8.76	1.46	6.0
PERP129C20	M-225	20	6.18	1.03	5.5
PERP129C18		18	7.90	1.31	5.5
PERP300C20	M-300	20	6.44	1.17	5.5
PERP525C20	M-525	20	8.58	1.56	5.5
PERP525C18		18	11.66	2.12	5.5
PERP600C20	M-600	20	9.30	1.69	5.5
PERP600C18		18	13.86	2.31	6.0
PERP725C18	M-725	18	14.74	2.68	5.5
PERP1400C18	1400	18	7.22	1.2	6.0
PERP1500C16	1500	16	14.42	2.4	6.0
PERP1500C14		14	17.63	2.93	6.0
PERP160C20	160	20	6.60	1.1	6.0
PERP160C18		18	9.00	1.5	6.0
PERP126C20	126	20	7.81	1.3	6.0
PERP126C18		18	10.28	1.71	6.0
PERP117C20	P-100	20	6.16	1.02	6.0
PERP117C18		18	8.16	1.36	6.0
PERP138C20	P-150	20	7.30	1.21	6.0
PERP138C18		18	9.66	1.61	6.0
PERP161C20	P-200	20	8.36	1.39	6.0
PERP161C18		18	11.16	1.86	6.0
PERP168C20	P-250	20	9.69	1.61	6.0
PERP168C18		18	12.78	2.13	6.0
PERP133C20	P-300	20	10.57	1.76	6.0
PERP133C18		18	13.95	2.32	6.0
PERP132C20	P-400	20	12.77	2.12	6.0
PERP132C18		18	16.92	2.82	6.0
PERP136C20	K-100	20	7.20	1.20	6.0
PERP136C18		18	9.48	1.58	6.0
PERP140C20	K-150	20	8.40	1.40	6.0
PERP140C18		18	10.98	1.83	6.0
PERP162C20	K-200	20	9.60	1.6	6.0
PERP135C20	K-300	20	11.28	1.88	6.0
PERP135C18		18	15.42	2.57	6.0

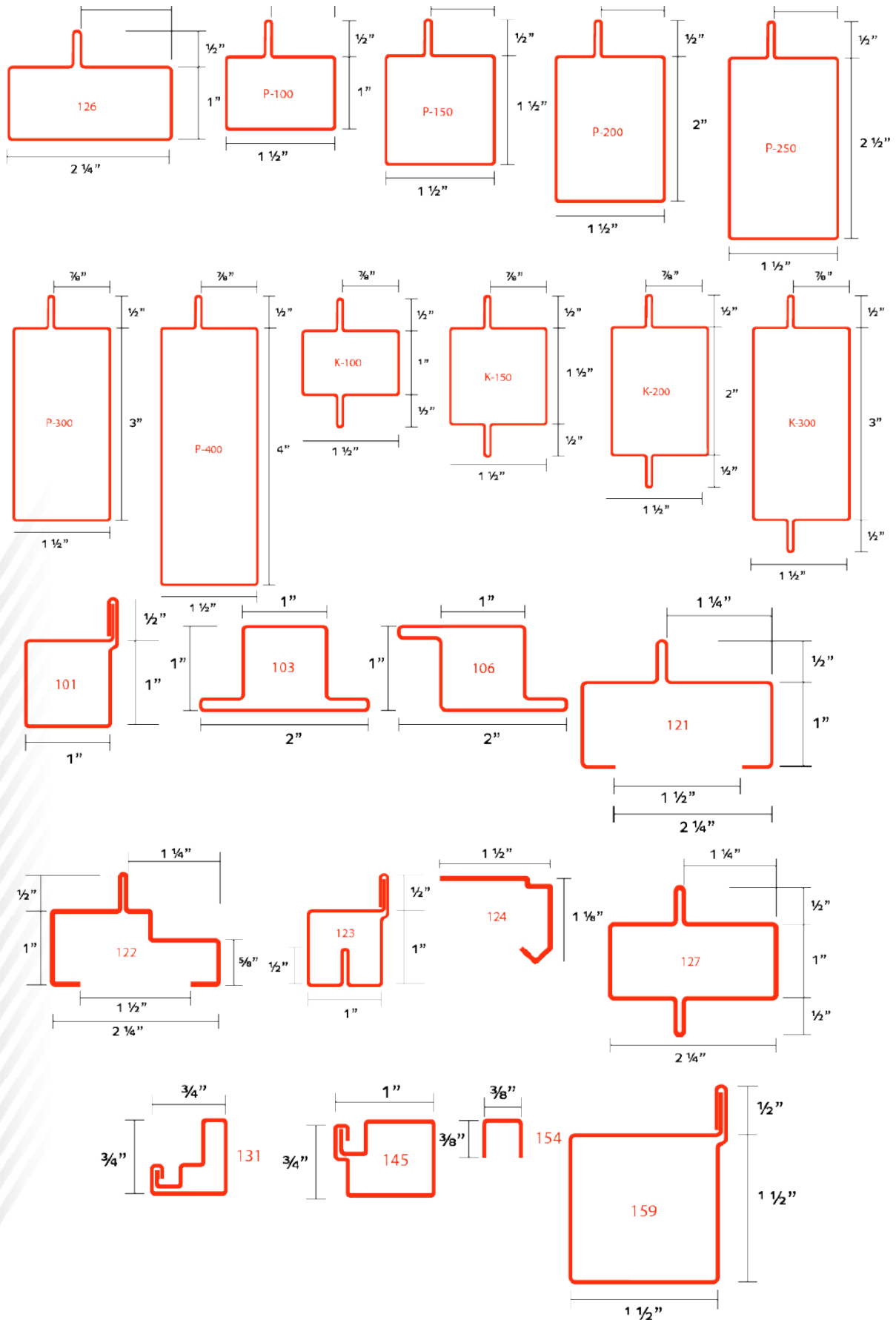

DUELAS

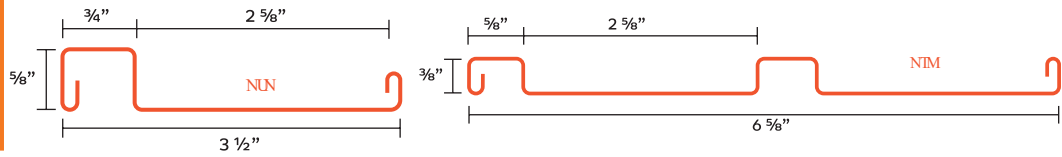
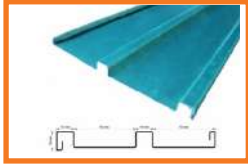

DUELAS

CÓDIGO	CALIBRE	KGXPIEZA	KG X METRO	LONGITUD M	PIEZAS X PAQUETE
170	20	9.24	1.54	6.0	60
171	20	5.16	0.86	6.0	120

TABLEROS

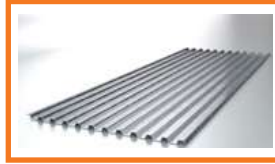

TABLEROS

CÓDIGO	MEDIDA	CALIBRE	LONGITUD (M)	KG X PIEZA
TZ-148	3X3	22*	0.91	4.96
	3X3	20	0.91	6
	3X6	22*	1.83	10
	3X6	20	1.83	11.95
	3X8	22*	2.44	13.3
	3X8	20	2.44	15.93
	3X10	22*	3.05	16.58
	3X10	20	3.05	19.92
	4X3	22	0.91	6.64
	4X3	20	0.91	7.97
	4X4	22	1.22	8.8
	4X4	20	1.22	10.63
	4X6	22	1.83	13.19
	4X6	20	1.83	15.94
	4X6.5	22	1.98	14.39
	4X6.5	20	1.98	17.25
	4X7	22	2.13	15.48
	4X7	20	2.13	18.55
	4X8	22	2.44	17.74
	4X8	20	2.44	21.25
4X10	22	3.05	22.08	
4X10	20	3.05	26.56	

PERFILES PARA VENTANA

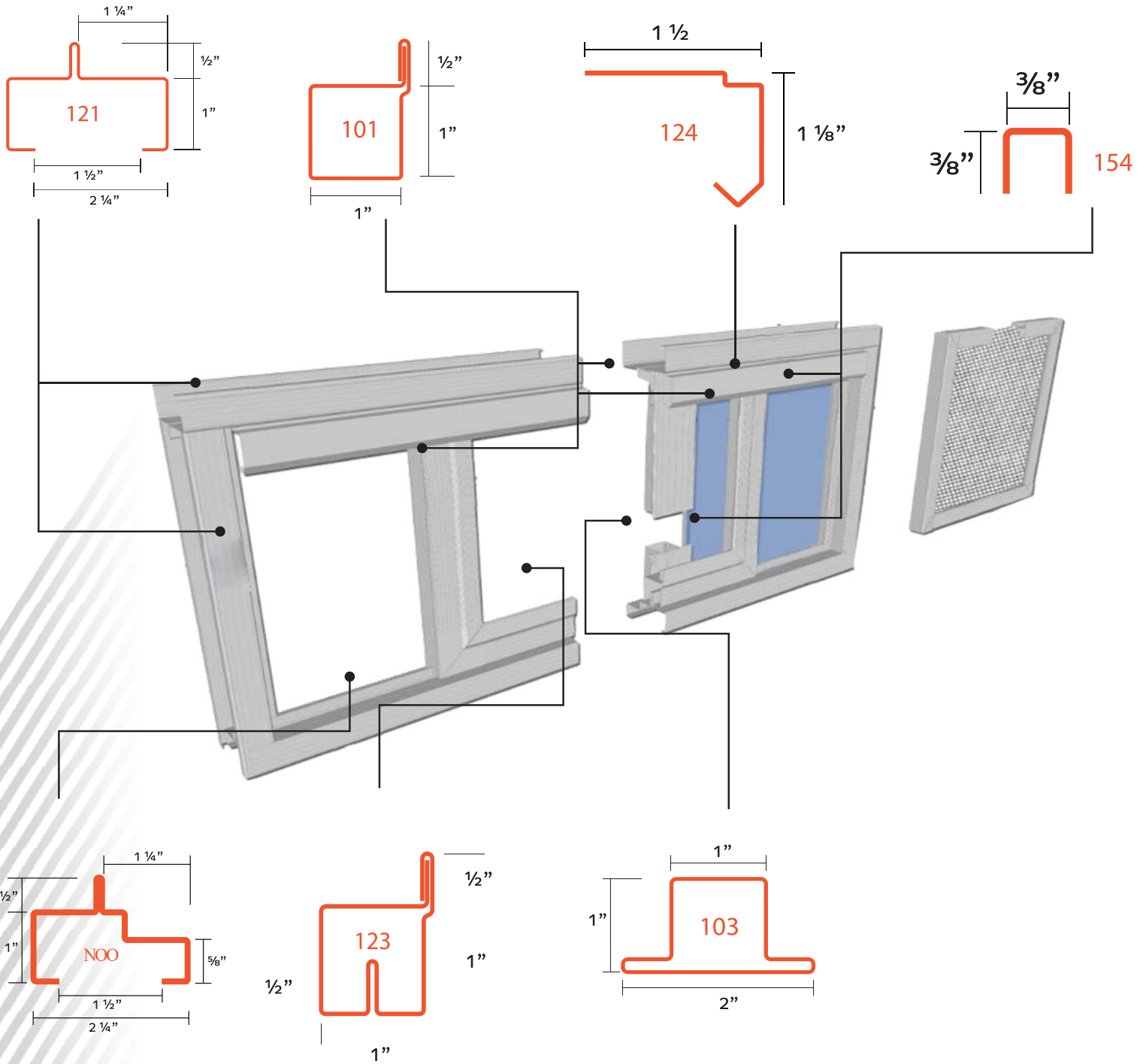

PERFILES PARA VENTANA				
CÓDIGO	CALIBRE	KG X PIEZA	KG X METRO	LONGITUD M
101	20	5.48	0.91	6.0
	18	7.32	1.22	6.0
103	20	6.48	1.08	6.0
	18	8.82	1.47	6.0
106	20	6.48	1.08	6.0
	18	8.82	1.47	6.0
121	20	6.14	1.02	6.0
	18	8.16	1.36	6.0
122	20	6.43	1.07	6.0
	18	8.16	1.36	6.0
123	20	6.43	1.07	6.0
124	18	4.09	0.68	6.0
127	20	8.87	1.47	6.0
	18	11.51	1.91	6.0
159	20	7.98	1.33	6.0
	18	10.86	1.81	6.0
154	20	1.11	0.18	6.0
	18	1.42	0.23	6.0
155	20	1.50	0.25	6.0v
156	20	2.34	0.39	6.0
M-221	20	8.76	1.46	6.0
M-225	20	6.18	1.03	5.5
	18	7.90	1.31	5.5
M-300	20	6.44	1.17	5.5
M-525	20	8.58	1.56	5.5
	18	11.66	2.12	5.5
M-600	20	9.30	1.69	5.5
	18	13.86	2.31	6.0
M-725	18	14.74	2.68	5.5
1400	18	7.22	1.2	6.0
1500	16	14.42	2.4	6.0
	14	17.63	2.93	6.0
160	20	6.60	1.1	6.0
	18	9.00	1.5	6.0

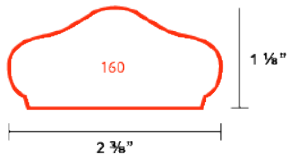
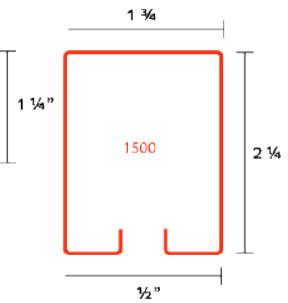
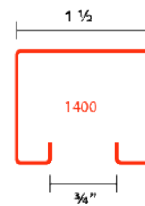
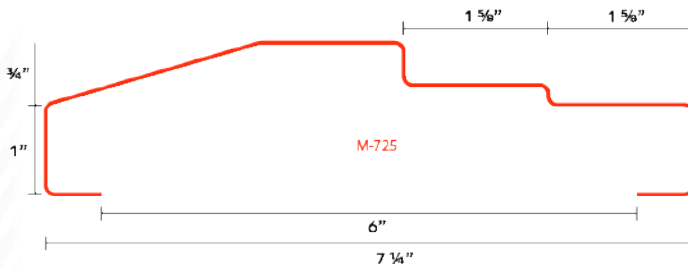
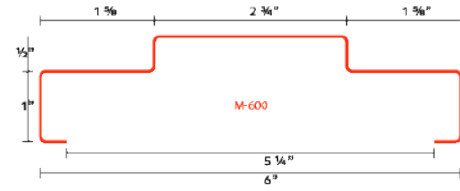
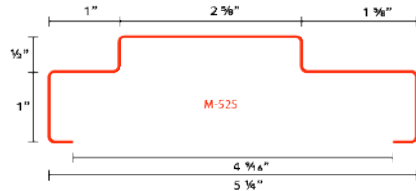
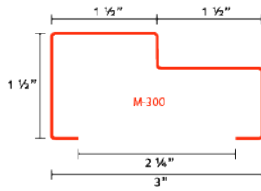
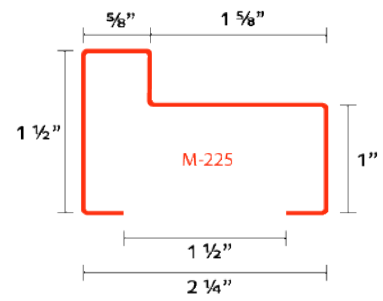
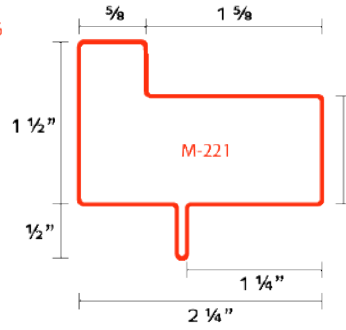
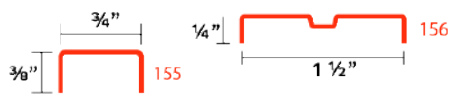

TUBERÍA CUADRADA



TUBERÍA CUADRADA					
CÓDIGO	DIAM IN	CALIBRE	KGXPIEZA	LONG M	KGXMETRO
C-050	0.500	22	1.62	6.00	0.27
		20	1.92	6.00	0.32
		18	2.46	6.00	0.41
		16	2.94	6.00	0.49
C-062	0.625	20	2.46	6.00	0.41
		18	3.18	6.00	0.53
		16	3.84	6.00	0.64
C-075	0.750	22	2.58	6.00	0.43
			3.00	6.00	0.50
	18	3.90	6.00	0.65	
		16	4.74	6.00	0.79
C-087	0.875	20	3.54	6.00	0.59
		18	4.62	6.00	0.77
C-100	1.000	20	4.14	6.00	0.69
		18	5.34	6.00	0.89
		16	6.54	6.00	1.09
		14	7.98	6.00	1.33
		13	9.30	6.00	1.55
		12	10.56	6.00	1.76
		11	11.70	6.00	1.95
10	12.78	6.00	2.13		

TUBERÍA CUADRADA					
CÓDIGO	DIAM IN	CALIBRE	KGXPIEZA	LONG M	KGXMETRO
C-125	1.250	20	5.22	6.00	0.87
		18	6.84	6.00	1.14
		16	8.40	6.00	1.40
		14	10.26	6.00	1.71
		12	13.74	6.00	2.29
		11	15.36	6.00	2.56
		10	16.86	6.00	2.81

TUBERÍA CUADRADA					
CÓDIGO	DIAM IN	CALIBRE	KGXPIEZA	LONG M	KGXMETRO
C-150	1.500	20	6.30	6.00	1.05
		18	8.28	6.00	1.38
		16	10.20	6.00	1.70
		14	12.54	6.00	2.09
		12	16.92	6.00	2.82
		11	18.96	6.00	3.16
		10	20.94	6.00	3.49
		9	22.80	6.00	3.80
C-175	1.750	16	12.00	6.00	2.00
		14	14.82	6.00	2.47
		11	22.62	6.00	3.77
C-200	2.000	20	8.46	6.00	1.41
		18	11.16	6.00	1.86
		16	13.86	6.00	2.31
		14	17.04	6.00	2.84
C-200	2.00	12	23.28	6.00	3.88
		11	26.28	6.00	4.38
		10	29.10	6.00	4.85
		9	32.45	6.10	5.32
		3/16	39.28	6.10	6.44
		1/4	49.17	6.10	8.06
C-225	2.25	16	15.66	6.00	2.61
		14	19.32	6.00	3.22

TUBERÍA CUADRADA

TUBERÍA CUADRADA					
C-250	2.50	16	17.46	6.00	2.91
		21.60	6.00	3.60	36
		13	25.68	6.00	4.28
		12	29.64	6.00	4.94
		11	33.54	6.00	5.59
		10	37.32	6.00	6.22
		9	41.04	6.00	6.84
		3/16	50.87	6.10	8.34
		1/4	64.60	6.10	10.59
C-300	3.00	14	26.16	6.00	4.36
		13	31.14	6.00	5.19
		12	36.00	6.00	6.00
		11	40.80	6.00	6.80
		10	45.48	6.00	7.58
		9	50.10	6.00	8.35
		3/16	62.46	6.10	10.24
		1/4	80.09	6.10	13.13
C-350	3.50	14	30.72	6.00	5.12
		11	48.06	6.00	8.01
		9	59.22	6.00	9.87
		3/16	74.05	6.10	12.14
		1/4	95.59	6.10	15.67
C-400	4.00	14	35.28	6.00	5.88
		11	55.38	6.00	9.23
		10	61.86	6.00	10.31
		9	68.34	6.00	11.39
		3/16	85.64	6.10	14.04
		1/4	111.02	6.10	18.20
C-450	4.50	11	62.64	6.00	10.44
		3/16	97.23	6.10	15.94
		1/4	126.51	6.10	20.74
C-500	5.00	3/16	108.89	6.10	17.85
		1/4	141.95	6.10	23.27
C-600	6.00	3/16	264.13	12.20	21.65
		1/4	345.87	12.20	28.35

TUBERÍA CUADRADA

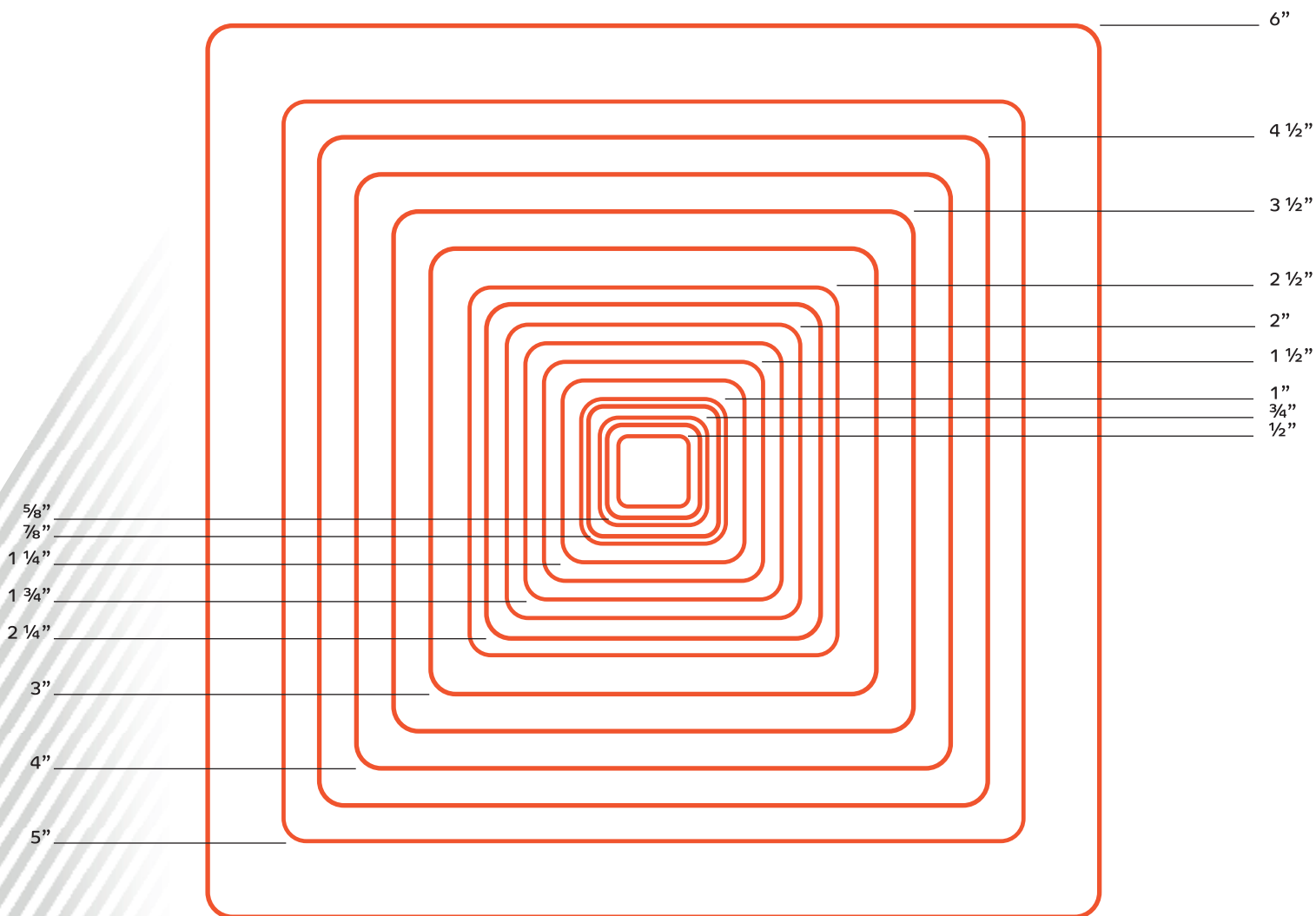

POLÍN C

*** SE FABRICA BAJO PEDIDO**

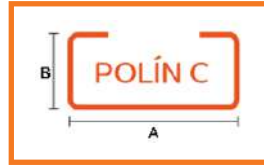

POLÍN C				
A X B (IN)	CALIBRE	KG X PIEZA	LONGITUD (M)	KG X METRO
3 X 1.5	16	13.20	6.0	2.20
	14*	12.50	5.0	2.50
	14	15.00	6.0	2.50
4 x 1.5	18*	11.40	6.0	1.90
	16*	14.40	6.0	2.40
	14*	11.60	4.0	2.90
	14*	14.50	5.0	2.90
	14*	17.40	6.0	2.90
4 x 2	18*	12.60	6.0	2.10
	16	16.20	6.0	2.70
	14	12.80	4.0	3.20
	14	16.00	5.0	3.20
	14	19.20	6.0	3.20
5 x 1.5	14*	19.80	6.0	3.30
	12*	27.00	6.0	4.50
	10*	34.20	6.0	5.70
5 x 2	16*	18.60	6.0	3.10
	14	18.00	5.0	3.60
	14	21.60	6.0	3.60
6 x 2	16*	20.40	6.0	3.40
	14	24.00	6.0	4.00
	12	33.60	6.0	5.60
	10	42.60	6.0	7.10
8 x 2.5	16*	33.60	8.0	4.20
	14	40.00	8.0	5.00
	12	58.40	8.0	7.30
	10	75.20	8.0	9.40
8 x 2.75	16*	35.2	8.0	4.40
	14	42.40	8.0	5.30
	12	61.60	8.0	7.70
	10	78.40	8.0	9.80
10 x 2.75	14	60.00	10.0	6.00
	12	87.00	10.0	8.70
	10	111.00	10.0	11.10
12 x 3.5	14	87.60	12.0	7.30
	12	138.00	12.0	11.50
	10	172.80	12.0	14.40

SOLERAS



SOLERAS					
DIMENSIONES				PESO	
PULG.		MM.			
ESPESOR	ANCHO	ESPESOR	ANCHO	KG./M	KG X PIEZA (6.10)
1/8	1/2	3.2	12.7	0.32	1.930
	3/4		19.1	0.47	2.890
	1		25.4	0.63	3.860
	1 1/4		31.7	0.79	5.000
	1 1/2		38.1	0.95	5.790
	2		50.8	1.26	7.720
	2 1/2		63.5	1.63	10.000
5/32	3/4	3.96	19.05	0.59	3.599
3/16	1/2	4.8	12.7	0.47	2.890
	3/4		19.1	0.71	6.610
	1		25.4	0.95	5.790
	1 1/4		31.7	1.18	7.240
	1 1/2		38.1	1.42	8.680
	2		50.8	1.89	11.580
	2 1/2		63.5	2.37	14.480
1/4	1/2	6.3	12.7	0.63	3.860
	3/4		19.1	0.95	5.795
	1		25.4	1.26	7.720
	1 1/4		31.7	1.58	9.650
	1 1/2		38.1	1.89	11.580
	2		50.8	2.53	15.440
	2 1/2		63.5	3.16	19.300
	3		76.2	3.79	23.160
	4		101.6	5.06	30.890
	5		127	6.33	38.600
	6		152.4	7.59	46.360
	8		203.2	10.12	61.780
	10		254	12.62	77.000
12	304.8	15.18	92.598		
5/16	1	7.9	25.4	1.58	9.650
	1 1/4		31.7	1.97	12.060
	1 1/2		38.1	2.37	14.500

SOLERAS

SOLERAS					
DIMENSIONES				PESO	
PULG.		MM.			
ESPESOR	ANCHO	ESPESOR	ANCHO	KG./M	KG X PIEZA (6.10)
5/16	2	9.5	50.8	3.16	19.300
	2 1/2		63.5	3.95	24.130
	3		76.2	4.75	28.960
	4		101.6	6.33	38.610
	5		127	7.91	48.270
	6		152.4	9.49	67.930
3/8	1	9.5	25.4	1.89	11.590
	1 1/4		31.7	2.37	14.500
	1 1/2		38.1	2.85	17.380
	2		50.8	3.79	23.170
	2 1/2		63.5	4.74	28.970
	3		76.2	5.69	34.760
	4		101.6	7.59	46.350
	5		127	9.49	57.930
	6		152.4	11.39	69.520
	8		203.2	15.28	93.210
	10		254	19.01	116.000
	12		304.8	22.78	139.000
1/2	1 1/2	12.7	38.1	3.79	23.170
	2		50.8	5.06	30.890
	2 1/2		63.5	6.33	38.620
	3		76.2	7.59	46.350
	4		101.6	10.13	61.790
	5		127	12.66	77.240
	6		152.4	15.19	92.690
	8		203.2	20.26	123.590
	10		254	25.24	154.000
	12		304.8	30.33	185.000
5/8	4	15.9	101.6	12.66	77.240
	5		127.0	15.82	96.540
	6		152.4	18.99	115.860
	8		203.2	25.32	154.500
	9		228.6	28.52	174.000
	10		254.0	31.63	193.000
	12		304.8	38.03	232.000

SOLERAS

SOLERAS					
DIMENSIONES				PESO	
PULG.		MM.			
ESPESOR	ANCHO	ESPESOR	ANCHO	KG./M	KG X PIEZA (6.10)
3/4	2 1/2	19.05	63.5	9.49	57.930
	3		76.2	11.39	69.500
	4		101.6	15.19	92.690
	5		127	18.99	115.860
	6		152.4	22.79	139.020
	8		203.2	30.38	185.370
	9		228.6	34.26	209.000
	10		254	38.03	232.000
	12		304.8	45.57	278.000
1	2	25.4	50.8	10.29	62.770
	3		76.2	15.19	92.690
	4		101.6	20.75	126.630
	5		127	25.32	154.470
	6		152.4	30.38	185.370
	8		203.2	40.49	247.000
	10		254	50.65	309.000
	12		304.8	60.81	371.000
1 1/8	3 1/7	28.6	80	17.93	109.373
1 1/2	6	38.1	152.4	45.55	277.855

TEE DE FIERRO

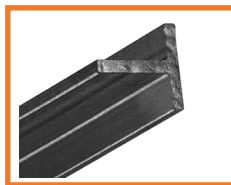

TEE DE FIERRO			
Clave	Medida	Peso x pieza (kg.)	Largo (m)
TEFIE109X1	TEE FIERRO 1/8X1 (8)	1.32	6.0

TUBO CERQUERO

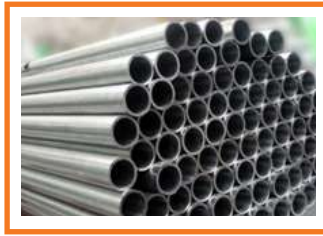

TUBO CERQUERO				
DIAM EXT IN	CALIBRE	KG X PIEZA	LONGITUD	KG X METRO
1	18	4.32	6.0	0.72
	16	5.34	6.0	0.89
1.315	20	4.38	6.0	0.73
	18	5.76	6.0	0.96
1.5	20	5.40	6.0	0.90
	18	6.60	6.0	1.10
1.66	20	5.58	6.0	0.93
	18	7.44	6.1	1.22
1.9	20	6.36	6.0	1.06
	18	8.46	6.0	1.41
	16	10.50	6.0	1.75
	14	13.02	6.0	2.17
2.38	18	10.62	6.0	1.77
	16	13.20	6.0	2.20
	14	16.38	6.0	2.73
2.88	18	12.90	6.0	2.15
	16	16.35	6.1	2.68
	14	19.92	6.0	3.32

TUBERÍA REDONDA

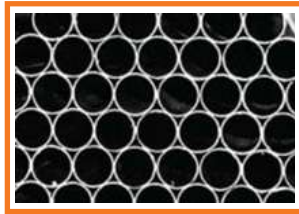

TUBERÍA REDONDA					
DESCRIPCIÓN IN	DIM IN	CALIBRE	KG X PIEZA	LONGITUD M	KG X METRO
1/2	0.500	22	1.320	6.00	0.22
		20	1.568	6.03	0.26
		18	2.050	6.03	0.34
5/8	0.625	22	1.688	6.03	0.28
		20	2.050	6.03	0.34
		18	2.653	6.03	0.44
	0.675	14	4.544	6.40	0.71
3/4	0.750	20	2.472	6.03	0.41
		18	3.196	6.03	0.53
		16	3.980	6.03	0.66
	0.840	13	6.848	6.40	1.07
7/8	0.875	20	2.894	6.03	0.48
		18	3.799	6.03	0.63
		16	4.643	6.03	0.77
		14	5.729	6.03	0.95
1	1.000	20	3.317	6.03	0.55
		18	4.342	6.03	0.72
		16	5.367	6.03	0.89
1 1/8	1.125	18	4.945	6.03	0.82
		14	7.538	6.03	1.25
1 1/4	1.250	20	4.161	6.03	0.69
		18	5.487	6.03	0.91
		16	6.814	6.03	1.13
		14	8.442	6.03	1.40
	1.315	20	4.402	6.03	0.73
		18	5.789	6.03	0.96
		16	7.176	6.03	1.19
		12	12.120	6.03	2.01
1 1/2	1.500	20	5.065	6.03	0.84

TUBERÍA REDONDA

TUBERÍA REDONDA					
DESCRIPCIÓN IN	DIM IN	CALIBRE	KG X PIEZA	LONGITUD M	KG X METRO
1 1/2	1.500	18	6.633	6.03	1.10
		16	8.261	6.03	1.37
		14	10.191	6.03	1.69
1 3/4	1.750	20	5.909	6.03	0.98
		18	7.779	6.03	1.29
		16	9.708	6.03	1.61
		14	12.000	6.03	1.99
1 7/8	1.875	20	6.720	6.40	1.05
		12	17.728	6.03	2.94
2	2.000	20	7.168	6.40	1.12
		18	8.924	6.03	1.48
		16	11.095	6.03	1.84
		14	13.809	6.03	2.29
2 1/8	2.125	14	14.653	6.03	2.43
2 1/4	2.250	18	10.070	6.03	1.67
		16	12.542	6.03	2.08
		14	15.557	6.03	2.58
2 1/2	2.500	18	11.216	6.03	1.86
		16	13.990	6.03	2.32
		14	17.366	6.03	2.88
2 3/4	2.750	11	30.150	6.03	5.00
3	3.000	18	13.507	6.03	2.24
		16	16.824	6.03	2.79
		14	20.924	6.03	3.47
3 1/2	3.500	13	29.306	6.03	4.86
		1/4	77.847	6.03	12.91
4 1/2	4.500	1/4	101.847	6.03	16.89

TUBERÍA REDONDA

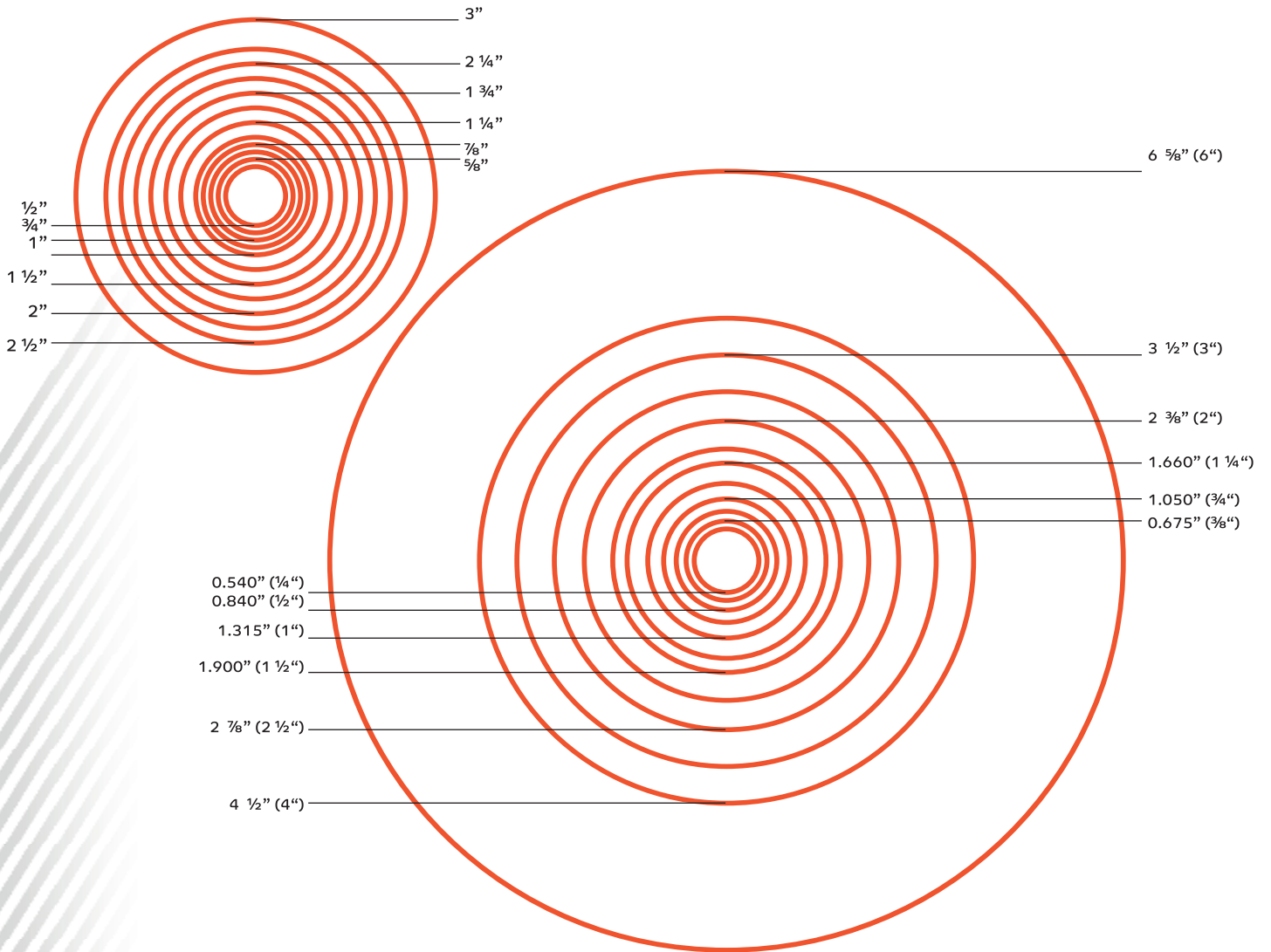

CÉDULA 30



CÉDULA 30					
DIAM IN	DIA EXT IN	CALIBRE	KG X PIEZA	LONGITUD M	KG X METRO
1/2	0.84	14	5.55	6.10	0.91
3/4	1.05	14	7.08	6.10	1.16
1	1.315	14	8.97	6.10	1.47
1 1/4	1.66	13	13.66	6.10	2.24
1 1/2	1.9	13	15.74	6.10	2.58
2	2 3/8	12	23.00	6.10	3.77
2 1/2	2 7/8	12	28.12	6.10	4.61
3	3 1/2	11	39.22	6.10	6.43
4	4 1/2	11	50.81	6.10	8.33
6	6 5/8	3/16	117.00	6.10	19.18

CÉDULA X



SOBRE PEDIDO

CÉDULA X				
DIAM IN	CALIBRE	KG X PIEZA	LONGITUD M	KG X METRO
2	10	30.66	6.4	4.79
2 1/2	9	41.47	6.4	6.48
3	3/16	63.17	6.4	9.87
4	3/16	82.24	6.4	12.85
6	3/16	122.75	6.4	19.18

CÉDULA 40



SOBRE PEDIDO

CÉDULA 40					
DIAM IN	DIA EXT IN	CALIBRE	KG X PIEZA	LONGITUD M	KG X METRO
1/4	0.54	14	3.52	6.40	0.55
3/8	0.68	13	5.31	6.40	0.83
1/2	0.84	12	7.81	6.40	1.22
3/4	1.05	12	10.05	6.40	1.57
1	1.32	10	16.13	6.40	2.52
1 1/4	1.66	10	20.86	6.40	3.26
1 1/2	1.90	10	26.62	6.40	4.16
2	2 3/8	9	31.74	6.00	5.29
2 1/2	2 7/8	1/5	51.26	6.40	8.01
3	3 1/2	4	74.69	6.40	11.67
4	4 1/2	4	97.54	6.40	15.24
6	6 5/8	0.280	180.74	6.40	28.24

CÉDULA 80



SOBRE PEDIDO

CÉDULA 80				
DIAM IN	CALIBRE	KGXPIEZA	LONGITUD M	KGXMETRO
2	4	49.02	6.4	7.66
2 1/2	1/4	66.75	6.4	10.43
3	5/16	101.31	6.4	15.83
4	5/16	133.12	6.4	20.8



**LÍNEA DE
PLANOS Y
LÁMINAS**

PLACA DE ACERO A 36 Y A50



PLACA DE ACERO A36 y A50													
MEDIDAS		3/16 4.8	1/4 6.3	5/16 7.9	3/8 9.5	7/16 11.1	1/2 12.7	5/8 15.9	3/4 19.1	7/8 22.5	1 25.4	1 1/4 31.7	1 1/2 38.1
PIES	MTS	KG/PZ	KG/PZ	KG/PZ	KG/PZ	KG/PZ	KG/PZ	KG/PZ	KG/PZ	KG/PZ	KG/PZ	KG/PZ	KG/PZ
3X8	.915x 2.44	83	111	140	167	200	222	280	333	390	445	555	680
3X10	.915x 3.05	104	139	173	208	250	278	350	416	485	555	695	835
3X20	.915x 6.10	210	280	350	415	505	560	730	870	970	1,110	1,390	1,670
4X6	.915x 2.44	85	115	140	165	200	225	280	335	390	445	555	680
4X8	.915x 2.44	111	148	185	222	270	296	370	445	520	592	740	905
4X10	1.22x 3.05	139	185	231	278	335	370	465	555	650	740	930	1,130
4X20	1.22x 6.10	280	390	462	555	670	740	970	1,170	1,300	1,480	1,855	2,265
5X10	1.52x 3.05	174	231	289	347	420	463	580	695	810	925	1,155	1,410
5X20	.915x 6.10	347	465	578	695	835	925	1,160	1,390	1,619	1,850	2,310	2,820
6X10	1.83x 6.10	205	280	347	416	500	560	725	870	980	1,110	1,390	1,670
6X20	1.83x 6.10	416	555	694	833	1,005	1,110	1,390	1,665	1,950	2,220	2,780	3,340
8X10	2.44x 3.05	280	373	465	555	670	940	965	1,170	1,310	1,480	1,855	2,265
8X20	2.44x 6.10	555	746	925	1,110	1,340	1,480	1,855	2,620	2,620	2,960	3,700	4,530

LÁMINA NEGRA ROLADA EN FRÍO



LÁMINA NEGRA ROLADA EN FRÍO								
PESOS TEORICOS POR HOJA (KG)								
Calibre	Pulgada	Espesor	3 X 6 .915 X 1.83	3 X 8 .915 X 2.44	3 X 10 .915 X 3.05	4 X 8 1.22 X 2.44	4 X 10 1.22 X 3.05	KG/M2
16	0.0598	1.52	20.400	27.200	34.040	36.300	45.390	12.206
18	0.0478	1.21	16.400	21.800	27.260	29.000	36.340	9.765
20	0.0359	0.91	12.300	16.300	20.410	21.800	27.590	7.324
22	0.0299	0.76	10.200	13.600	17.010	18.200	22.680	6.103
24	0.0239	0.61	8.160	10.900	13.600	14.600	18.144	4.882
26	0.0179	0.45	6.120	8.200	10.620	10.900	13.340	3.663

LÁMINA NEGRA ROLADA EN CALIENTE



LÁMINA NEGRA ROLADA EN CALIENTE							
PESOS TEORICOS POR HOJA (KG)							
Calibre	Pulgada	Espesor	3 X 6 .915 X 1.83	3 X 8 .915 X 2.44	3 X 10 .915 X 3.05	4 X 8 1.22 X 2.44	4 X 10 1.22 X 3.05
14	0.075	1.89	25.5	34	42.8	45.4	56.7
12	0.1046	2.66	35.7	47.6	59.5	63.5	79.4
11	0.1196	3.04	40.8	54.4	68	72.6	90.7
10	0.1345	3.42	46	61.3	76.6	81.6	102.58

PLACA ANTIDERRAPANTE



PLACA ANTIDERRAPANTE								
MEDIDAS	1/8 kg/pz	3/16 kg/pz	1/4 kg/pz	5/16 kg/pz	3/8 kg/pz	C-11 kg/pz	C-12 kg/pz	C-14 kg/pz
ESPESOR	0.125 3.17	0.1875 4.76	0.25 6.35	0.313 7.9	0.375 9.5	0.1146 3.4	0.1046 2.66	0.0747 1.9
3 X 8	68	95	125	150	175	55	50	40
3 X 10	85	120	156	185	220	70	62	45
4 X 8	90	130	166	195	233	72	65	50
4 X 10	113	162	208	245	290	90	85	62

LÁMINA LAMINA GALVALUME R072



Ancho efectivo 72 cm (28.3")



LÁMINA GALVALUME R072			
CALIBRE	PODER CUBRIENTE	PERALTE (mm)	LARGO
22*, 24,26,28,30,32	72 cm	25	1.00 A 12.20 m

LAMINA GALVALUME R072		
CLAVE	DESCRIPCIÓN	LARGO (m)
GALVALUME072244	LAMINA GALVALUME R072 C32	2.44
GALVALUME072305	LAMINA GALVALUME R072 C32	3.05
GALVALUME072366	LAMINA GALVALUME R072 C32	3.66
GALVALUME072427	LAMINA GALVALUME R072 C32	4.27
GALVALUME072488	LAMINA GALVALUME R072 C32	4.88
GALVALUME072550	LAMINA GALVALUME R072 C32	5.5
GALVALUME072610	LAMINA GALVALUME R072 C32	6.1
GALVALUME072732	LAMINA GALVALUME R072 C32	7.32

LÁMINA ALUMINIO ZINC R-101



LÁMINA ALUMINIO ZINC R-101	
CALIBRE	Peso kg/ml
28	3.92
26	4.64
24	5.36
22	7.52

COMPLEMENTO PARA LÁMINAS DE TECHAR

VARILLA ROSCADA

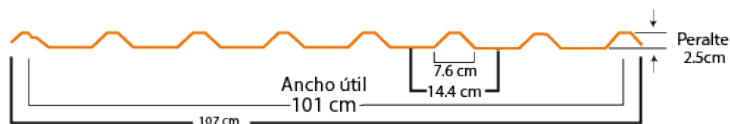

VARILLA ROSCADA	
FH-VR05	VARILLA ROSCADA 05 (3/16)
FH-VR06	VARILLA ROSCADA 06 (1/4)
FH-VR09	VARILLA ROSCADA 09 (3/8)
FH-VR12	VARILLA ROSCADA 12 (1/2)
FH-VR16	VARILLA ROSCADA 16 (5/8)
FH-VR191	VARILLA ROSCADA 19 (1")
FH-VR19	VARILLA ROSCADA 19 (3/4)

Elaborada en acero 1010 en acabado galvanizado.

BIRLO PARA LÁMINA



BIRLO PARA LÁMINA	
BI1/4X10	BIRLO PARA LAMINA 1/4 X 10
BI1/4X12	BIRLO PARA LAMINA 1/4 X 12
BI3/16X10	BIRLO PARA LAMINA 3/16 X 10
BI3/16X12	BIRLO PARA LAMINA 3/16 X 12
BI3/16X4	BIRLO PARA LAMINA 3/16 X 4
BI3/16X6	BIRLO PARA LAMINA 3/16 X 6
BI3/16X8	BIRLO PARA LAMINA 3/16 X 8

Elaborada en acero 1010 en acabado galvanizado.

LAMINA LISA GALVANIZADA



LÁMINA LISA GALVANIZADA A						
CALIBRE	3X10	3X6	3X8	4X10	4X6	4X8
	PESO POR PIEZA					
C/10	75.55	-----	-----	122.91	-----	-----
C/11	-----	-----	-----	100.00	-----	-----
C/12	58.93	-----	47.14	-----	-----	-----
C/14	42.50	-----	-----	56.50	-----	-----
C/16	34.01	20.40	27.21	45.35	27.21	36.28
C/18	27.36	16.42	21.89	36.48	22.00	29.18
C/20	20.74	12.44	16.59	27.63	16.58	21.70
C/22	17.39	10.43	13.91	23.18	13.91	18.54
C/24	12.38	7.43	10.00	16.60	9.92	13.50
C/26	10.74	6.44	8.59	14.30	8.58	11.40
C/28	9.06	5.44	7.25	12.08	7.25	9.66
C/30	7.44	4.47	5.95	-----	-----	-----

LAMINA GALVATEJA ROJA



SOBRE PEDIDO

Ancho efectivo 100 cm

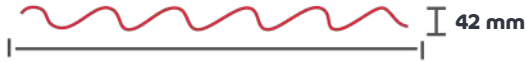

LAMINA GALVATEJA ROJA		
COLOR	PODER CUBRIENTE	LARGO
Rojo Janitzio	1.00	2.44 a 6.10 m

LAMINA GALVATEJA ROJA		
CLAVE	DESCRIPCIÓN	LARGO (m)
LAMGALV244	LAMINA GALVATEJA ROJA JANITZIO	2.44
LAMGALV305	LAMINA GALVATEJA ROJA JANITZIO	3.05
LAMGALV366	LAMINA GALVATEJA ROJA JANITZIO	3.66
LAMGALV427	LAMINA GALVATEJA ROJA JANITZIO	4.27
LAMGALV488	LAMINA GALVATEJA ROJA JANITZIO	4.88
LAMGALV550	LAMINA GALVATEJA ROJA JANITZIO	5.50
LAMGALV610	LAMINA GALVATEJA ROJA JANITZIO	6.10

LÁMINA LOSACERO



LÁMINA LOSACERO		
CALIBRE	PODER CUBRIENTE	LARGO
20, 22 y 24	91.5 cm	2.44 A 12.20 m

LÁMINA LOSACERO			
CLAVE	CALIBRE	PESO X PIEZA (kg.)	LARGO (m)
LAMLOS610C20	LAMINA LOSACERO C/20 SEC 4	52.5	6.10
LAMLOS610C22	LAMINA LOSACERO C/22 SEC 4	44	6.10
LAMLOS610C24	LAMINA LOSACERO C/24 SEC 4	37	6.10
LAMLOSA732C24	LAMINA LOSACERO C/22 SEC 4	53	7.32

LAMINA LISA PINTRO

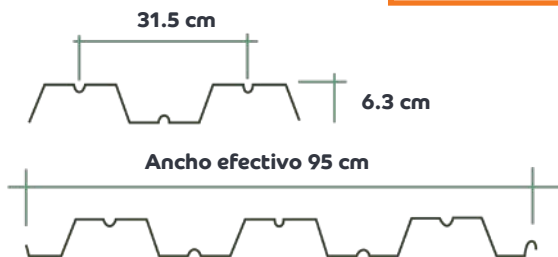

SOBRE PEDIDO

LAMINA LISA GALVANIZADA		
CLAVE	CALIBRE	MEDIDA
LAM3X10C24	LAMINA LISA PINTRO C/24	3 X 10
LAM3X10C26	LAMINA LISA PINTRO C/26	3 X 10
LAM4X10C22	LAMINA LISA PINTRO C/22	4 X 10
LAM4X10C24	LAMINA LISA PINTRO C/24	4 X 10
LAM4X10C26	LAMINA LISA PINTRO C/26	4 X 10
LAM4X8C22	LAMINA LISA PINTRO C/22	4 X 8

LAMINA PINTRO R-101



SOBRE PEDIDO

LAMINA LISA GALVANIZADA			
CLAVE	CALIBRE	PESO X PIEZA (KG)	LARGO (M)
LAMP101244C24	LAMINA PINTRO R101 C/24	13.23	2.44
LAMP101250C24	LAMINA PINTRO R101 C/24	13.55	2.50
LAMP101250C24	LAMINA PINTRO R101 C/24	13.55	2.50
LAMP101305C24	LAMINA PINTRO R101 C/24	16.54	3.05
LAMP101366C24	LAMINA PINTRO R101 C/24	19.85	3.66
LAMP101427C24	LAMINA PINTRO R101 C/24	23.15	4.27
LAMP101426C24	LAMINA PINTRO R101 C/24	23.64	4.36
LAMP101488C24	LAMINA PINTRO R101 C/24	26.45	4.88
LAMP101550C24	LAMINA PINTRO R101 C/24	29.81	5.50
LAMP101610C24	LAMINA PINTRO R101 C/24	33.07	6.10
LAMP101732C24	LAMINA PINTRO R101 C/24	39.68	7.32
LAMP101150C26	LAMINA PINTRO R101 C/26	7.05	1.50
LAMP101305C26	LAMINA PINTRO R101 C/26	14.31	3.05
LAMP101366C26	LAMINA PINTRO R101 C/26	17.17	3.66
LAMP101427C26	LAMINA PINTRO R101 C/26	20.05	4.27
LAMP101488C26	LAMINA PINTRO R101 C/26	22.89	4.88
LAMP101550C26	LAMINA PINTRO R101 C/26	25.80	5.50
LAMP101610C26	LAMINA PINTRO R101 C/26	28.61	6.10
LAMP101732C26	LAMINA PINTRO R101 C/26	40.90	8.70
LAMP101955C26	LAMINA PINTRO R101 C/26	44.79	9.55
LAMP10110C26	LAMINA PINTRO R101 C/26	49.25	10.50

CANAleta PARA DESAÜE

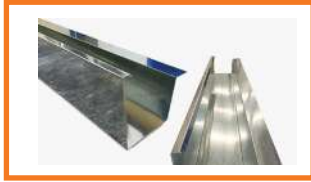

CANAleta PARA DESAÜE

CANALETGALV4X3C	CANAleta CUADRADA 4 X 3.05 CAL 26
CANALETGALV4X3C30	CANAleta CUADRADA 4 X 3.05 CAL 30
CANALETGALV6X3C	CANAleta CUADRADA 6 X 3.05 CAL 26
CANALETGALV6X3C30	CANAleta CUADRADA 6 X 3.05 CAL 30

REMATE PARA CANAleta



REMATE PARA CANAleta

REMCAN4C26DER	REMATE CANAL 4" C/26 CON TAPA Y SALIDA DER
REMCAN4C26IZQ	REMATE CANAL 4" C/26 CON TAPA Y SALIDA IZQ

CABALLETE GALVANIZADO LISO



CABALLETE GALVANIZADO LISO

CABALLR1013.05X	CABALLETE GALV R101 3.05x.45 C/26
CABALLR1003.05X	CABALLETE LISO R100 3.05X.45 C/24 (MULTYTECHO)

CABALLETE PINTRO

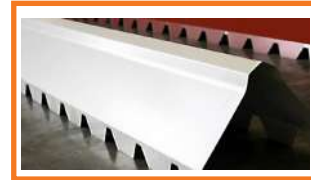

CABALLETE GALVANIZADO LISO

CABALLR10113.05C24	CABALLETE PINTRO R101 DENTADO 3.05X.45 C/24
CABPIN26	CABALLETE PINTRO R101 DENTADO 3.05X.45 C/26
CABALLR1013.05C26	CABALLETE PINTRO R101 DENTADO 3.05X.61 C/26

CABALLETE GALVATEJA



CABALLETE GALVATEJA

CABALL	CABALLETE PARA GALVATEJA
--------	--------------------------

PANEL MULTITECHO

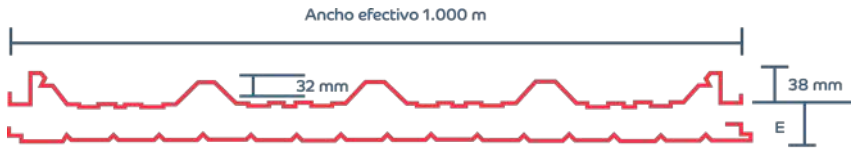

PANEL MULTITECHO				
ESPESOR (mm)	CALIBRE	LARGO (m)	PESO APROXIMADO KG/M2	PRESENTACIÓN COLOR
1.5	26/28	2.5 a 12.00	9.98	BLANCO

TAPA GOTERO PARA MULTITECHO



TAPA GOTERO PARA MULTITECHO	
TAPGOT38C22	TAPAGOTERO 1½ PARA GLAMET A 3.05

CLIP SUJECIÓN PARA MULTITECHO



CLIP SUJECIÓN PARA MULTITECHO	
GLAMETCLIP	CLIP DE SUJECION PARA GLAMET



LÍNEA LAMITEC

DUELAS A BASE DE LÁMINA DE ACERO

Duelas a base de lámina de acero calibre 22. Disponible en lámina verde y negro.

*Lámina verde con un galvanizado capa G60, puede pintarse sin necesidad de primer.

Ideal para la fabricación de portones, paneles, puertas, gabinetes etc.



*Estampado en cuadrado, rectángulo y combinados.

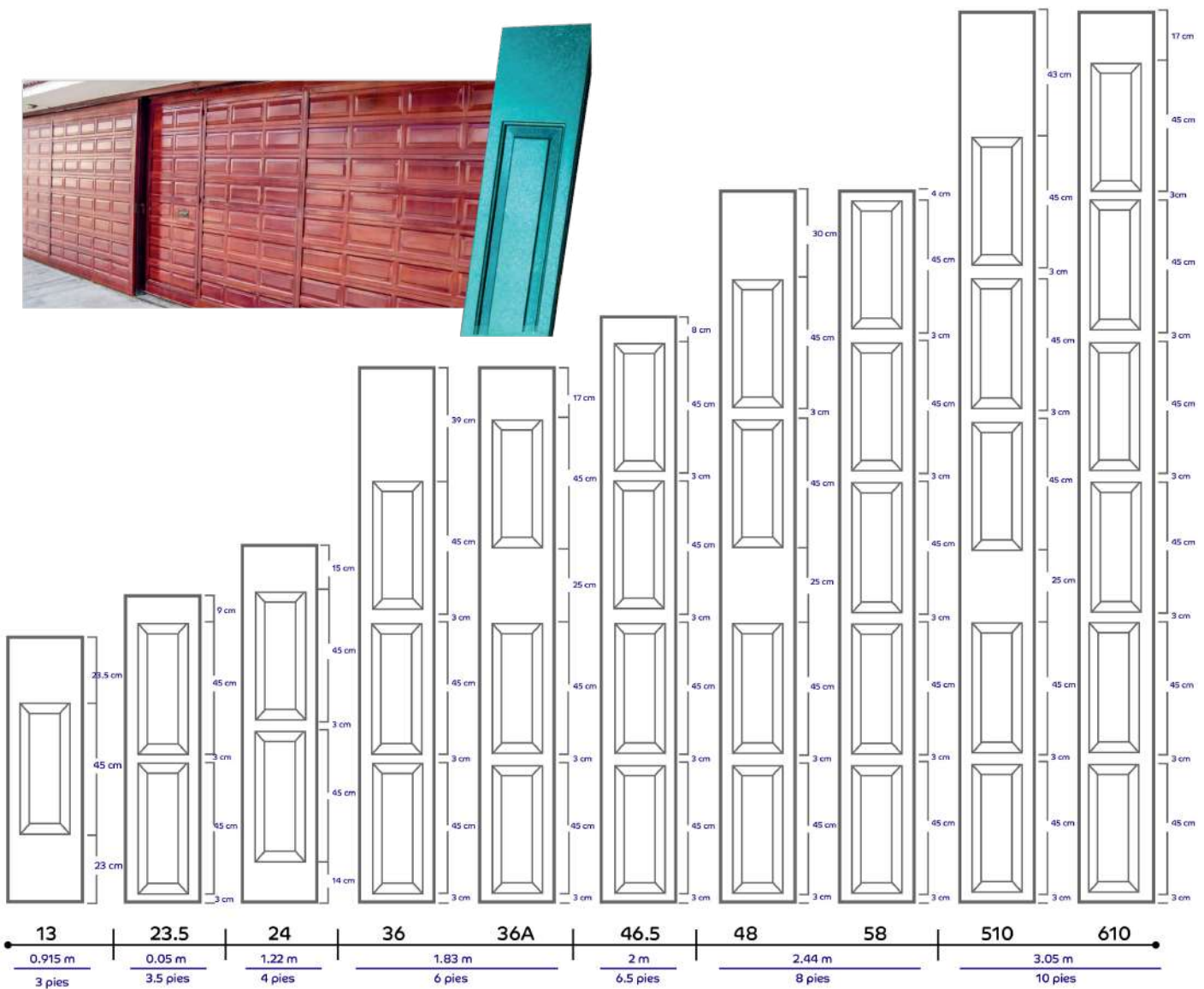

*Estampado en rectángulo.

DUELAS A BASE DE LÁMINA DE ACERO

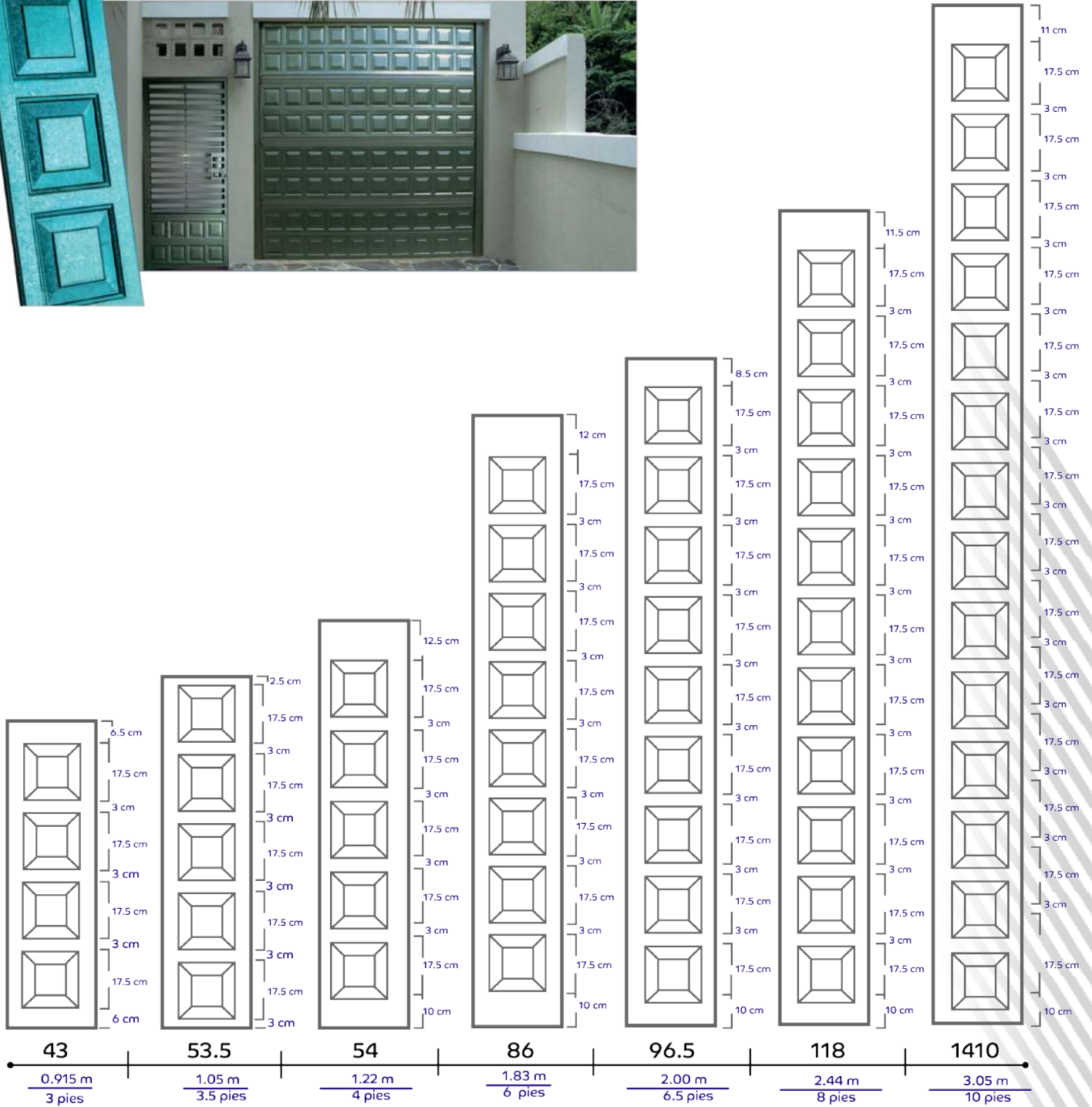

*Estampado en cuadrado.

DUELAS A BASE DE LÁMINA DE ACERO

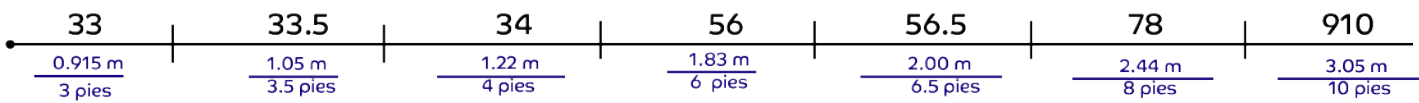
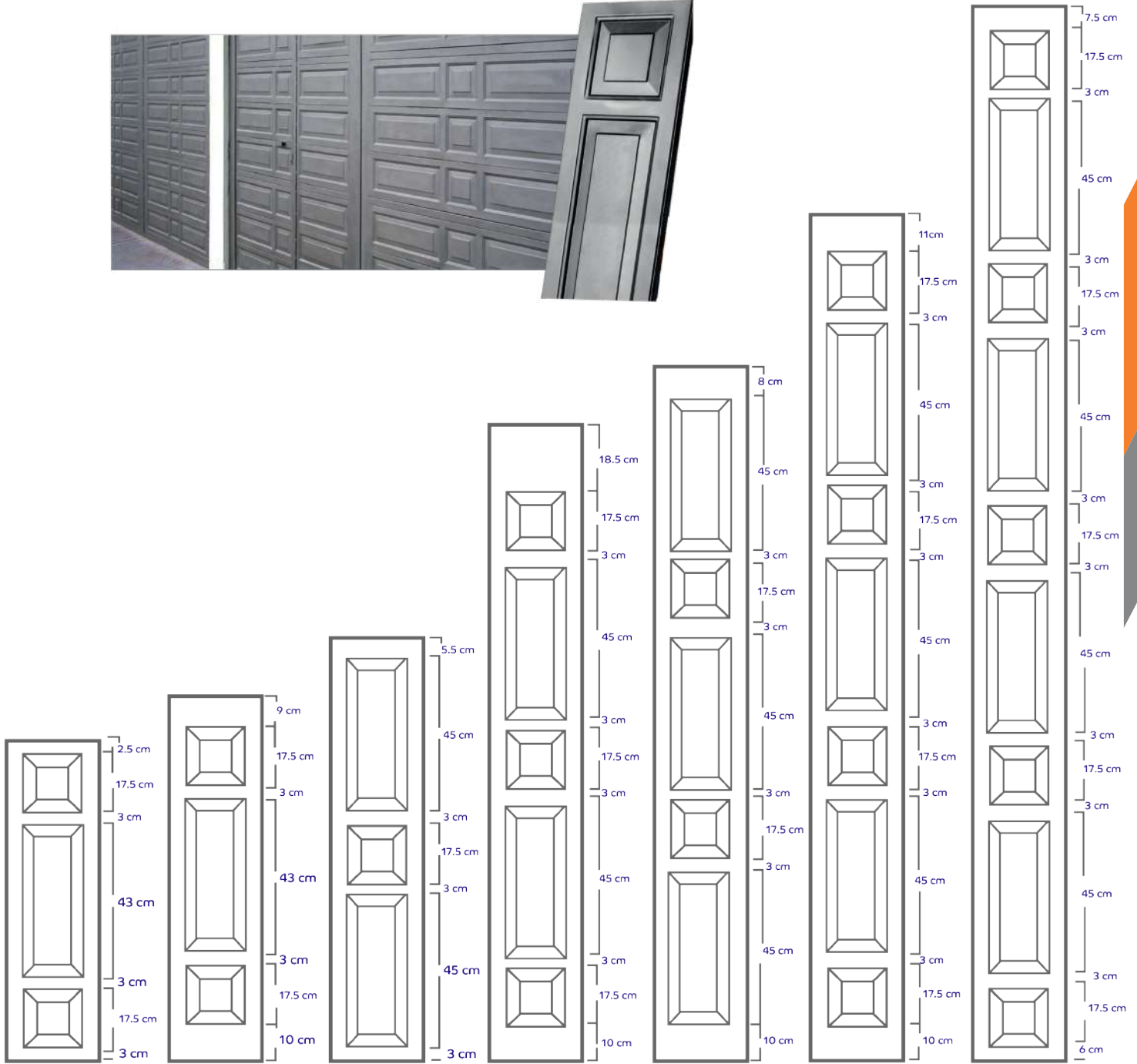

*Estampado en cuadro rectángulo

Diseño clásico de superficie lisa.
 Duelas a base de lámina de acero calibre 22.
 Compatibilidad para intercalar entre todos los
 modelos LAMITEC sin necesidad de soldadura,
 gracias al sistema LAMICLICK.



ALTURA ANCHO	1.83 m	2.00 m	2.44 m	3.05 m
	6 pies	6.5 pies	8 pies	10 pies
2 CM	DT20-060	DT20-065	DT20-080	DT20-100
4 CM	DT40-060	DT40-065	DT40-080	DT40-100
6 CM	DT60-060	DT60-065	DT60-080	DT60-100
8 CM	DT80-060	DT80-065	DT80-080	DT80-100
10 CM	DT100-060	DT100-065	DT100-080	DT100-100
12.5 CM	DT125-060	DT125-065	DT125-080	DT125-100

DUELATEC



* Posibilidad de diseño con ambas caras (frente y vuelta)

Anchos

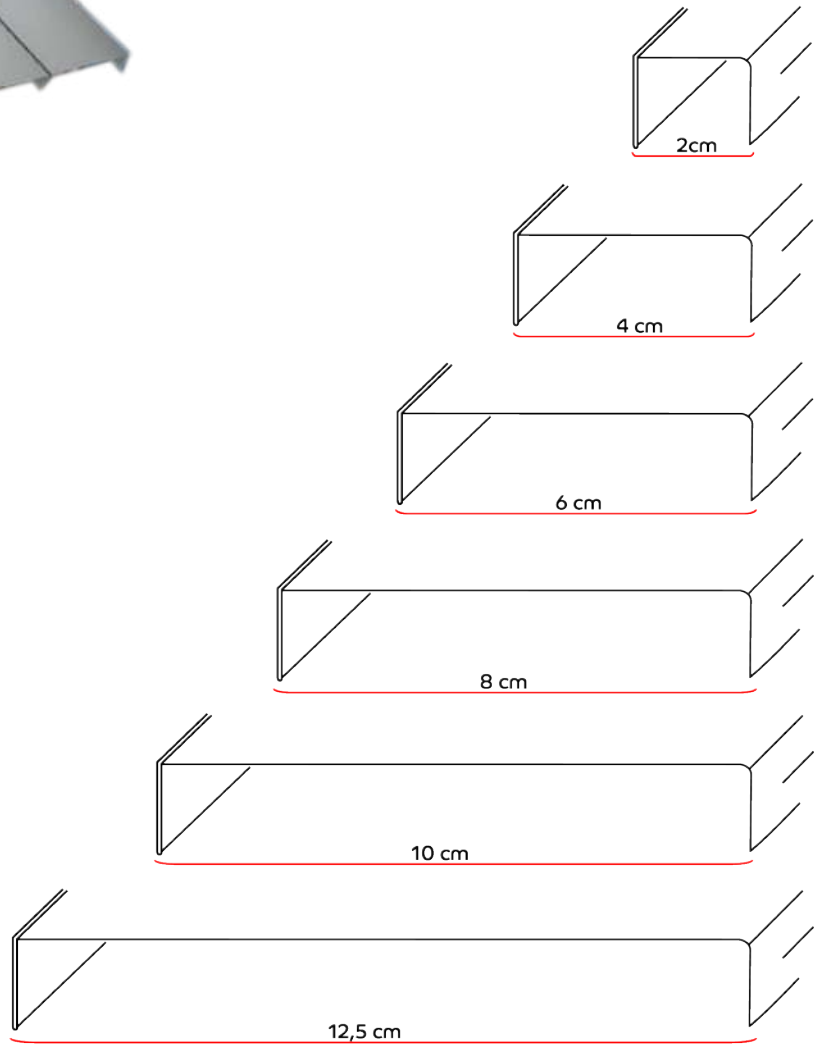

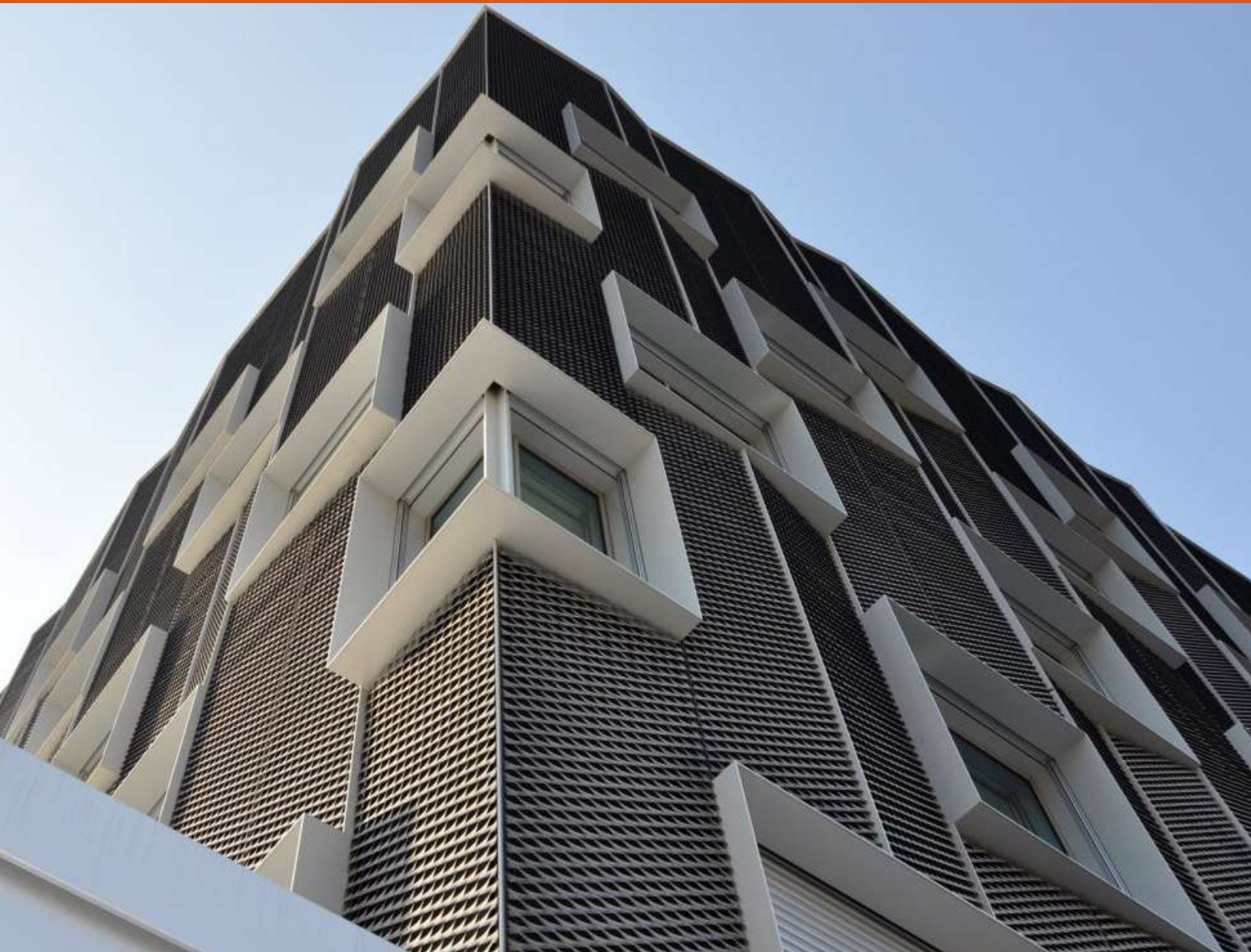

**LÍNEA DE
METAL
DESPLÉGADO**

METAL DESPLEGADO Y LÁMINA PERFORADA *SOLO SOBRE PEDIDO

CIELO FALSO

Es un metal desplegado para cielo, falso preferido para la construcción de cielos falsos, plafones, canceles, muros ligeros, marquesinas, etc. Disponible en acero al carbón y galvanizado.



CIELO FALSO										
CATÁLOGO	ABERTURA DE LA MALLA				ESPESOR		SECCIÓN		PESO	
	LCR		LLR		PULG.	MM.	PULG.	MM.	IBS/PIE2	KGS/M2
	PULG.	MM.	PULG.	MM.						
10-K	0.5	12.7	1.25	31.8	0.018	0.45	0.033	0.8	0.11	0.5
E6-22	0.5	12.7	1.25	31.8	0.018	0.45	0.04	1.0	0.12	0.6
E7-22	0.5	12.7	1.25	31.8	0.018	0.45	0.045	1.1	0.14	0.7
E8-22	0.5	12.7	1.25	31.8	0.018	0.45	0.052	1.3	0.16	0.8
E9-22	0.5	12.7	1.25	31.8	0.018	0.45	0.059	1.4	0.02	0.9
E10-22	0.5	12.7	1.25	31.8	0.018	0.45	0.066	1.6	0.20	1.00



Resistente malla de acero fabricado en una sola pieza con pequeñas aberturas, diseñada para evitar el paso de insectos y para brindar una mayor seguridad que otros productos. Ideal para aplicarse como malla mosquitera en puertas y ventanas. Presentación en rollos y en hojas.

MOSQUI-RED EN ROLLO						
CATÁLOGO	CALIBRE	SECCIÓN (mm)	TIPO DE LÁMINA		MEDIDAS (m)	
			ACERO AL CARBÓN	GALVANIZADA		
1/8 " #24PR	24	0.7	si	si	.91 x 11	
1/8 " #24PR	24	0.7	si	si	1.22 x 11	
1/8 " #26PR	26	0.7	si	si	1.22 x 114	1.22 x 30
1/8 " #26PR	26	0.7	si	si	1.22 x 114	1.22 x 30
					.91 x 11	.91 x 30

MOSQUI-RED EN HOJA						
CATÁLOGO	CALIBRE	SECCIÓN (mm)	TIPO DE LÁMINA		MEDIDAS (m)	
			ACERO AL CARBÓN	GALVANIZADA		
1/8 " #24PR	24	0.7	si	si	.91 x 2.13	1.22 x 2.13
1/8 " #24PR	24	0.7	si	si	.91 x 2.13	1.22 x 2.13
1/8 " #26PR Zig-Zag	26	0.7	si	si	.91 x 2.13	
1/8 " #26PR Barroco	26	0.7	si	si	.91 x 2.13	

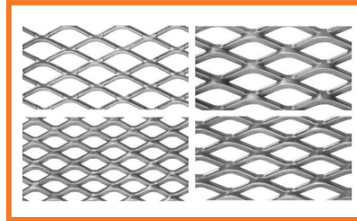

FILTRO RED

Ideal para la fabricación de los filtros de aire para automóviles, motores estacionarios, tractores y equipos de construcción, adicionalmente sirve para los filtros de aire de sistemas de aire acondicionado, así como extractores de aire domésticos y comerciales.

Elaborado de lámina galvanizada, resistente a la corrosión, fácil de manejar y ensamblar, posee una gran flexibilidad y resistencia.

FILTRO RED												
CATÁLOGO	ABERTURA DE LA MALLA				ESPESOR		SECCIÓN		PESO		DIMENSIÓN DEL ROLLO	
	LCR		LLR		PULG.	MM.	PULG.	MM.	IBS/PIE ²	KG/M ²	LLR	LCR
	PULG.	MM.	ANCHO M	LARGO M								
FR-180 PR	0.1	2.5	0.18	4.5	0.010	0.25	0.0014	0.3	0.10	0.50	0.4	62
FR-500 FR	0.25	6.4	0.50	12.7	0.010	0.25	0.028	0.7	0.10	0.50	.40 Y .61	62 Y 65
C13-26 PR	0.34	8.71	0.62	15.8	0.017	0.45	0.039	1.0	0.18	0.90	0.91	11
C14-24 PR	0.34	8.71	0.62	15.8	0.021	0.53	0.039	1.0	0.22	1.08	0.91	11
C15-22 PR	0.34	8.71	0.62	15.8	0.029	0.46	0.039	1.0	0.27	1.31	0.91	11
C16-20 PR	0.34	8.71	0.62	15.8	0.036	0.91	0.039	1.5	0.51	2.49	0.91	11

MDI ROLLOS



METAL DESPLEGADO

Es una malla metálica formada de una sola pieza, sin costura ni soldadura, que presenta una serie de aberturas de tamaño uniforme en forma de rombos o diamantes.

USO: Protección de maquinaria en movimiento, muebles para jardín, protección de corrientes de alta tensión, guardas protectoras, paneles, divisores de talleres, etc.

METAL-RED.

Metal desplegado natural sin acabado adicional. El producto lo conforman diamantes que quedan orientados en ángulo respecto al plano original de la hoja sólida.

MD ROLLOS SIN PLANCHAR ACERO AL CARBÓN

CATÁLOGO	ABERTURA DE LA MALLA				ESPESOR		SECCIÓN		PESO		DIMENSIÓN DEL ROLLO	
	LCR		LLR		PULG.	MM.	PULG.	MM.	IBS/PIE ²	KG/M ²	ANCHO M	LARGO M
	PULG.	MM.	PULG.	MM.								
A4-26 MR	0.12	3.1	0.25	6.3	0.017	0.45	0.039	1.0	0.5	2.44	.91 & 1.22	11
B8-26 MR	0.19	4.7	0.39	9.9	0.017	0.45	0.039	1.0	0.3	1.45	.91 & 1.22	11
B9-24 MR	0.19	4.7	0.39	9.9	0.024	0.61	0.039	1.0	0.4	1.95	.91 & 1.22	11
B10-22MR	0.19	4.7	0.39	9.9	0.030	0.76	0.039	1.0	0.5	2.44	.91 & 1.22	11
B11-20 MR	0.19	4.7	0.39	9.9	0.035	0.91	0.039	1.0	0.6	2.93	.91 & 1.22	11
C13-26 MR	0.31	7.9	0.62	15.8	0.017	0.45	0.039	1.0	0.18	0.90	.91 & 1.22	11
C14-24 MR	0.31	7.9	0.62	15.8	0.024	0.61	0.039	1.0	0.25	1.20	.91 & 1.22	11
C15-22 MR	0.31	7.9	0.62	15.8	0.030	0.76	0.059	1.5	0.47	2.30	.91 & 1.22	11
C16-20 MR	0.31	7.9	0.62	15.8	0.035	0.91	0.059	1.5	0.57	2.77	.91 & 1.22	11
D17-24 MR	0.44	11.1	0.87	22.2	0.024	0.61	0.059	1.5	0.28	1.35	.91 & 1.22	11
D18-22 MR	0.44	11.1	0.87	22.2	0.030	0.76	0.059	1.5	0.35	1.70	.91 & 1.22	11
D19-20 MR	0.44	11.1	0.87	22.2	0.035	0.91	0.059	1.5	0.41	2.00	.91 & 1.22	11
D20-18 MR	0.44	11.1	0.87	22.2	0.047	1.21	0.059	1.5	0.55	2.70	.91 & 1.22	11
D21-16MR	0.44	11.1	0.87	22.2	0.060	1.52	0.059	1.5	0.69	3.35	.91 & 1.22	11
E23-22 MR	0.50	12.7	1.23	31.2	0.030	0.76	0.078	2.0	0.41	2.00	.91 & 1.22	11
E24-20 MR	0.50	12.7	1.23	31.2	0.035	0.91	0.078	2.0	0.49	2.40	.91 & 1.22	11
E25-18 MR	0.50	12.7	1.23	31.2	0.047	1.21	0.078	2.0	0.67	3.25	.91 & 1.22	11
E26-16 MR	0.50	12.7	1.23	31.2	0.060	1.52	0.078	2.0	0.84	4.10	.91 & 1.22	11
E27-14 MR	0.50	12.7	1.23	31.2	0.075	1.90	0.078	2.0	1.04	5.10	.91 & 1.22	11
G32-20 MR	0.75	19.0	1.62	41.2	0.035	0.91	0.098	2.5	0.37	1.80	.91 & 1.22	11
G33-18 MR	0.75	19.0	1.62	41.2	0.047	1.21	0.098	2.5	0.49	2.40	.91 & 1.22	11
G34-16 MR	0.75	19.0	1.62	41.2	0.060	1.52	0.098	2.5	0.61	3.00	.91 & 1.22	11
G35-14 MR	0.75	19.0	1.62	41.2	0.075	1.90	0.098	2.5	0.78	3.80	.91 & 1.22	11
H36-20 MR	0.98	25.0	2.00	50.8	0.035	0.91	0.118	3.0	0.36	1.75	.91 & 1.22	11
H37-18 MR	0.98	25.0	2.00	50.8	0.047	1.21	0.118	3.0	0.47	2.30	.91 & 1.22	11
H38-16 MR	0.98	25.0	2.00	50.8	0.060	1.52	0.118	3.0	0.59	2.90	.91 & 1.22	11
H39-14 MR	0.98	25.0	2.00	50.8	0.075	1.90	0.118	3.0	0.74	3.60	.91 & 1.22	11
H40-12 MR	0.98	25.0	2.00	50.8	0.104	2.66	0.118	3.0	1.05	5.15	.91 & 1.22	11
H40-12L MR	0.98	25.0	2.00	50.8	0.090	2.28	0.107	2.7	0.8	3.91	.91 & 1.22	11
J45-16 MR	1.33	33.8	3.00	76.2	0.060	1.52	0.157	4.0	0.57	2.80	.91 & 1.22	11
J46-14 MR	1.33	33.8	3.00	76.2	0.075	1.90	0.157	4.0	0.72	3.50	.91 & 1.22	11
J47-12 MR	1.33	33.8	3.00	76.2	0.104	2.66	0.157	4.0	1.00	4.90	.91 & 1.22	11
J47-12L MR	1.33	33.8	3.00	76.2	0.090	2.28	0.124	3.2	0.68	3.34	.91 & 1.22	11
J48-10 MR	1.33	33.8	3.00	76.2	0.134	3.42	0.157	4.0	1.28	6.25	.91 & 1.22	11
J48-10L MR	1.33	33.8	3.00	76.2	0.120	3.04	0.147	3.7	1.08	5.27	.91 & 1.22	11



LÁMINA LOUVER.

El desplegado louver tiene diversas aplicaciones, entre ellas como una barrera de seguridad revolucionaria, ideal para bardas perimetrales. Elaborada a base de lámina de acero al carbón y se instala fácilmente con costos muy bajos.

LÁMINA LOUVER												
CATÁLOGO		ABERTURA DE LA MALLA		ESPESOR		SECCIÓN		PESO		DIMENSIÓN DE LA HOJA		
		LCR	LLR	PULG.	MM.	PULG.	MM.	LBS/PIE2	KG/M2	LLR	LCR	
		PULG.	MM.							ANCHO M	LARGO M	
LOUVER MESH 70-20	1.02	25.9	3.00	76.2	0.036	0.91	0.350	8.9	1.0	4.90	0.91 & 1.22	2.44, 3.05 & 3.65
LOUVER MESH 70-18	1.02	25.9	3.00	76.2	0.048	1.22	0.350	8.9	1.3	6.54	0.91 & 1.22	2.44, 3.05 & 3.65
MINI LOUVER 75-14	0.5	12.7	1.20	30.4	0.075	1.90	0.188	4.7	2.3	11.22	1.22 & 1.53	2.44, 3.05 & 3.65
LOUVER MESH 94-16	1.28	32.3	3.00	76.2	0.060	1.52	0.600	15.2	2.3	11.22	1.22 & 1.53	2.44, 3.05 & 3.65
LOUVER MESH 94-14	1.28	32.3	3.00	76.2	0.075	1.90	0.600	15.2	2.9	14.04	1.22 & 1.53	2.44, 3.05 & 3.65
LOUVER 94 PERFORADO	1.28	32.3	3.00	76.2	0.060	1.52	0.600	15.2	1.6	7.68	1.22	2.44 & 3.65
LOUVER 2"	2.21	56.0	5.91	150.0	0.047	1.21	0.846	21.5	1.5	7.31	1.22	2.44 & 3.65

REJILLA IRVING DENTADA GALVANIZADA

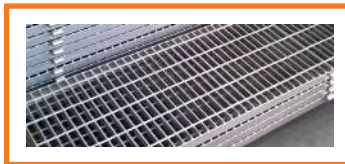

REJILLA IRVING DENTADA GALVANIZADA	
REIRGDENGAL 3X25	REJILLA IRVING DENTADA GALVANIZADA 1X1/8
REIRVDENGAL 4X25	REJILLA IRVING DENTADA GALVANIZADA 1X3/16

REJILLA TIPO IRVING LISA

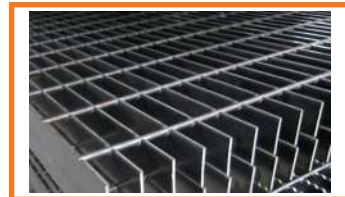

REJILLA TIPO IRVING LISA	
REJIRVLI 316 X 2.05	REJILLA TIPO IRVING LISA CAL. 3/16 X 2 1/2 1X 6 MTS
REIRVDENGAL 4 X 25	REJILLA TIPO IRVING LISA C 3/16 X 3/4" 1X6 MTS

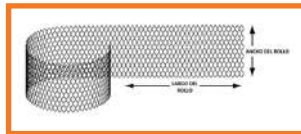

PLANO-RED.

Metal desplegado sometido a un proceso adicional de rolado en frío, lo que permite presentar una superficie completamente lisa. El producto lo conforman diamantes en posición horizontal respecto al plano original de la hoja sólida.

MD ROLLOS SIN PLANCHAR ACERO AL CARBÓN												
CATÁLOGO	ABERTURA DE LA MALLA				ESPESOR		SECCIÓN		PESO		DIMENSIÓN DEL ROLLO	
	LCR		LLR		PULG.	MM.	PULG.	MM.	IBS/PIE2	KG/M2	ANCHO M	LARGO M
	PULG.	MM.	PULG.	MM.								
A4-26 MR	0.13	3.4	0.25	6.3	0.017	0.45	0.039	1.0	0.45	2.20	.91 & 1.22	11
B8-26 MR	0.20	5.2	0.39	9.9	0.017	0.45	0.039	1.0	0.27	1.31	.91 & 1.22	11
B9-24 MR	0.20	5.2	0.39	9.9	0.024	0.61	0.039	1.0	0.36	1.76	.91 & 1.22	11
B10-22MR	0.20	5.2	0.39	9.9	0.030	0.76	0.039	1.0	0.45	2.20	.91 & 1.22	11
B11-20 MR	0.20	5.2	0.39	9.9	0.035	0.91	0.039	1.0	0.54	2.64	.91 & 1.22	11
C13-26 MR	0.34	8.7	0.62	15.8	0.017	0.45	0.039	1.0	0.18	0.90	.91 & 1.22	11
C14-24 MR	0.34	8.7	0.62	15.8	0.024	0.61	0.039	1.0	0.25	1.20	.91 & 1.22	11
C15-22 MR	0.34	8.7	0.62	15.8	0.030	0.76	0.059	1.5	0.47	2.30	.91 & 1.22	11
C16-20 MR	0.34	8.7	0.62	15.8	0.035	0.91	0.059	1.5	0.57	2.77	.91 & 1.22	11
D17-24 MR	0.48	12.1	0.87	22.2	0.024	0.61	0.059	1.5	0.25	1.22	.91 & 1.22	11
D18-22 MR	0.48	12.1	0.87	22.2	0.030	0.76	0.059	1.5	0.31	1.53	.91 & 1.22	11
D19-20 MR	0.48	12.1	0.87	22.2	0.035	0.91	0.059	1.5	0.37	1.80	.91 & 1.22	11
D20-18 MR	0.48	12.1	0.87	22.2	0.047	1.21	0.059	1.5	0.50	2.43	.91 & 1.22	11
D21-16MR	0.48	12.1	0.87	22.2	0.060	1.52	0.059	1.5	0.62	3.02	.91 & 1.22	11
E23-22 MR	0.57	14.6	1.23	31.2	0.030	0.76	0.078	2.0	0.37	1.80	.91 & 1.22	11
E24-20 MR	0.57	14.6	1.23	31.2	0.035	0.91	0.078	2.0	0.44	2.16	.91 & 1.22	11
E25-18 MR	0.57	14.6	1.23	31.2	0.047	1.21	0.078	2.0	0.60	2.93	.91 & 1.22	11
E26-16 MR	0.57	14.6	1.23	31.2	0.060	1.52	0.078	2.0	0.76	3.69	.91 & 1.22	11
E27-14 MR	0.57	14.6	1.23	31.2	0.075	1.90	0.078	2.0	0.94	4.59	.91 & 1.22	11
G32-20 MR	0.87	22.2	1.62	41.2	0.035	0.91	0.098	2.5	0.33	1.62	.91 & 1.22	11
G33-18 MR	0.87	22.2	1.62	41.2	0.047	1.21	0.098	2.5	0.44	2.16	.91 & 1.22	11
G34-16 MR	0.87	22.2	1.62	41.2	0.060	1.52	0.098	2.5	0.55	2.70	.91 & 1.22	11
G35-14 MR	0.87	22.2	1.62	41.2	0.075	1.90	0.098	2.5	0.70	3.42	.91 & 1.22	11
H36-20 MR	1.06	26.9	2.00	50.8	0.035	0.91	0.118	3.0	0.32	1.58	.91 & 1.22	11
H37-18 MR	1.06	26.9	2.00	50.8	0.047	1.21	0.118	3.0	0.42	2.07	.91 & 1.22	11
H38-16 MR	1.06	26.9	2.00	50.8	0.060	1.52	0.118	3.0	0.53	2.61	.91 & 1.22	11
H39-14 MR	1.06	26.9	2.00	50.8	0.075	1.90	0.118	3.0	0.66	3.24	.91 & 1.22	11
H40-12 MR	1.06	26.9	2.00	50.8	0.104	2.66	0.118	3.0	0.95	4.64	.91 & 1.22	11
H40-12L MR	1.06	26.9	2.00	50.8	0.090	2.28	0.107	2.7	0.77	3.74	.91 & 1.22	11
J45-16 MR	1.50	38.1	3.00	76.2	0.060	1.52	0.157	4.0	0.52	2.52	.91 & 1.22	11
J46-14 MR	1.50	38.1	3.00	76.2	0.075	1.90	0.157	4.0	0.64	3.15	.91 & 1.22	11
J47-12 MR	1.50	38.1	3.00	76.2	0.104	2.66	0.157	4.0	0.89	4.35	.91 & 1.22	11
J47-12L MR	1.50	38.1	3.00	76.2	0.090	2.28	0.124	3.2	0.62	3.01	.91 & 1.22	11
J48-10 MR	1.50	38.1	3.00	76.2	0.134	3.42	0.157	4.0	1.13	5.54	.91 & 1.22	11
J48-10L MR	1.50	38.1	3.00	76.2	0.120	3.04	0.150	3.8	0.97	4.74	.91 & 1.22	11



METAL DESPLEGADO EXTRA ANCHO.

Metal desplegado en rollos de 5 pies de ancho, lo cual agrega una alternativa más para optimizar su operación.

DESPLEGADO EXTRA ANCHO SIN PLANCHAR EN ACERO AL CARBÓN												
CATÁLOGO	ABERTURA DE LA MALLA				ESPESOR		SECCIÓN		PESO		DIMENSIÓN DEL ROLLO	
	LCR		LLR		PULG.	MM.	PULG.	MM.	IBS/PIE2	KG/M2	ANCHO M	LARGO M
	PULG.	MM.	PULG.	MM.								
E25-18 MR	0.50	12.7	1.23	31.2	0.048	1.21	0.079	2.0	0.67	3.25	1.52	11.00
E26-16 MR	0.50	12.7	1.23	31.2	0.060	1.52	0.079	2.0	0.84	4.10	1.52	11.00
G33-18 MR	0.75	19.0	1.63	41.2	0.048	1.21	0.098	2.5	0.49	2.40	1.52	11.00
G34-16 MR	0.75	19.0	1.63	41.2	0.060	1.52	0.098	2.5	0.62	3.00	1.52	11.00
G35-14 MR	0.75	19.0	1.63	41.2	0.075	1.90	0.098	2.5	0.78	3.80	1.52	11.00
H39-14 MR	0.98	25.0	2.00	50.8	0.075	1.90	0.118	3.0	0.74	3.60	1.52	11.00
H40-12L MR	0.98	25.0	2.00	50.8	0.090	2.28	0.107	2.7	0.80	3.91	1.52	11.00
J47-12L MR	1.33	33.8	3.00	76.2	0.090	2.28	0.124	3.2	0.68	3.34	1.52	11.00
J48-10L MR	1.33	33.8	3.00	76.2	0.120	3.04	0.147	3.7	1.08	5.27	1.52	11.00

DESPLEGADO EXTRA ANCHO PLANCHADO EN ACERO AL CARBÓN												
CATÁLOGO	ABERTURA DE LA MALLA				ESPESOR		SECCIÓN		PESO		DIMENSIÓN DEL ROLLO	
	LCR		LLR		PULG.	MM.	PULG.	MM.	IBS/PIE2	KG/M2	ANCHO M	LARGO M
	PULG.	MM.	PULG.	MM.								
E25-18 MR	0.58	14.6	1.23	31.2	0.048	1.21	0.079	2.0	0.60	2.93	1.52	11.00
E26-16 MR	0.58	14.6	1.23	31.2	0.060	1.52	0.079	2.0	0.76	3.69	1.52	11.00
G33-18 MR	0.87	22.2	1.63	41.2	0.048	1.21	0.098	2.5	0.44	2.16	1.52	11.00
G34-16 MR	0.87	22.2	1.63	41.2	0.060	1.52	0.098	2.5	0.55	2.70	1.52	11.00
G35-14 MR	0.87	22.2	1.63	41.2	0.075	1.90	0.098	2.5	0.70	3.42	1.52	11.00
H39-14 MR	1.06	26.9	2.00	50.8	0.075	1.90	0.118	3.0	0.66	3.24	1.52	11.00
H40-12L MR	1.06	26.9	2.00	50.8	0.090	2.28	0.111	2.8	0.77	3.74	1.52	11.00
J47-12L MR	1.50	38.1	3.00	76.2	0.090	2.28	0.124	3.2	0.62	3.01	1.52	11.00
J48-10L MR	1.50	38.1	3.00	76.2	0.120	3.04	0.15	3.8	0.97	4.74	1.52	11.00

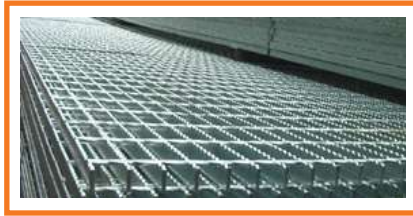

GRATING

Piso antiderrapante fabricado a partir de acero laminado de calidad controlada y espesores hasta 5/16" (7.92mm). Por su diseño permite una distribución uniforme de la carga sobre la superficie. Elaborado a partir de placa de acero, sin soldaduras y sin costuras. Sus aplicaciones son para mezzanines, plataformas de mantenimiento, pasillos elevados peatonales, rampas, plataformas de seguridad, escaleras industriales, etc.

METAL DESPLEGADO INDUSTRIAL ESTRUCTURAL												
CATÁLOGO	ABERTURA DE LA MALLA				ESPESOR		SECCIÓN		PESO		DIMENSIÓN DEL ROLLO	
	LCR		LLR		PULG.	MM.	PULG.	MM.	IBS/ PIE2	KG/ M2	LLR	LCR
	PULG.	MM.	PULG.	MM.							ANCHO M	LARGO M
GR-1500	1.34	34.0	5.32	135.0	0.185	4.70	0.26	6.6	2.99	14.60	1.22	2.44 & 3.05
GR-1570	2.01	51.0	5.99	152.0	0.252	6.40	0.307	7.8	3.14	15.30	1.22	2.44 & 3.05
GR-2000	1.34	34.0	5.32	135.0	0.217	5.50	0.295	7.5	3.99	19.50	1.22	2.44 & 3.05
GR-2100	1.42	36.0	4.02	102.0	0.252	6.40	0.295	7.5	4.26	20.80	1.22	2.44 & 3.05
GR-2500	1.34	34.0	5.32	135.0	0.252	6.40	0.327	8.3	4.99	24.40	1.22	2.44 & 3.05
GR-3000	1.34	34.0	5.32	135.0	0.311	7.90	0.346	8.8	6.25	30.50	1.22	2.44 & 3.05
GR-3500	1.42	36.0	5.32	135.0	0.311	7.90	0.39	9.9	6.99	34.10	1.22	2.44 & 3.05

METAL DESPLEGADO ANTIDERRAPANTE PARA CORREDORES O PASILLOS INDUSTRIALES												
CATÁLOGO	ABERTURA DE LA MALLA				ESPESOR		SECCIÓN		PESO		DIMENSIÓN DEL ROLLO	
	LCR		LLR		PULG.	MM.	PULG.	MM.	IBS/ PIE2	KG/ M2	LLR	LCR
	PULG.	MM.	PULG.	MM.							ANCHO M	LARGO M
GR-1000 CW	1.34	34.0	5.32	135.0	0.133	3.40	0.272	6.9	1.99	9.76	0.61	3.05
GR-1500 CW	1.34	34.0	5.32	135.0	0.185	4.70	0.260	6.6	2.99	14.60	.61, 0.91 & 1.22	3.05
GR-1570 CW	2.01	51.0	5.99	152.0	0.252	6.40	0.307	7.8	3.15	15.30	.61, 0.91 & 1.22	3.05
GR-2000 CW	1.34	34.0	5.32	135.0	0.216	5.50	0.295	7.5	3.99	19.50	.61, 0.91 & 1.22	3.05
GR-2100 CW	1.42	36.0	4.02	102.0	0.252	6.40	0.295	7.5	4.26	20.80	.61, 0.91 & 1.22	3.05
GR-2500 CW	1.34	34.0	5.32	135.0	0.252	6.40	0.327	8.3	4.99	24.40	.61, 0.91 & 1.22	3.05

SQUARE MESH

Igualando los lados del diamante, se consigue un producto más ligero y con mayor paso de aire y temperatura. Mayor diversidad de aplicaciones como muebles para exterior, elementos arquitectónicos, estantería, etc. Puede reemplazar cribas de alambre, metal perforado y otros productos elaborados en acero al carbón.



SQUARE MESH												
CATÁLOGO		ABERTURA DE LA MALLA		ESPESOR		SECCIÓN		PESO		DIMENSIÓN DE LA HOJA		
		LCR	LLR	PULG.	MM.	PULG.	MM.	LBS/ PIE2	KG/ M2	LLR	LCR	
		PULG.	MM.							ANCHO M	LARGO M	
SGR 1/4 #20 PR	0.25	6.3	0.31	7.8	0.033	0.83	0.033	0.8	0.40	1.80	1.22	11
SGR 1/4 #18 PR	0.25	6.3	0.31	7.8	0.043	1.09	0.043	1.0	0.60	3.00	1.22	11
SGR 1/2 #20 PR	0.50	12.7	0.62	15.6	0.033	0.83	0.033	0.8	0.20	0.90	1.22	11
SGR 1/2 #18 PR	0.50	12.7	0.62	15.6	0.043	1.09	0.043	1.0	0.30	1.50	1.22	11
SGR 1/2 #16 PR	0.50	12.7	0.62	15.6	0.055	1.39	0.055	1.3	0.50	2.40	1.22	11
SGR 3/4 #18 PR	0.75	19.0	0.98	25.0	0.043	1.09	0.043	1.0	0.20	0.98	1.22	11
SGR 3/4 #16 PR	0.75	19.0	0.98	25.0	0.055	1.39	0.055	1.3	0.35	1.60	1.22	11
SGR 3/4 #14 PR	0.75	19.0	0.98	25.0	0.070	1.77	0.070	1.7	0.55	2.60	1.22	11
SGR 1 #16 PR	1.00	25.4	1.23	31.2	0.055	1.39	0.059	1.3	0.25	1.20	1.22	11
SGR 1 #14 PR	1.00	25.4	1.23	31.2	0.070	1.77	0.070	1.7	0.40	1.93	1.22	11
SGR 1 #12 PR	1.00	25.4	1.23	31.2	0.100	2.54	0.100	2.5	0.80	3.80	1.22	11

REJACERO

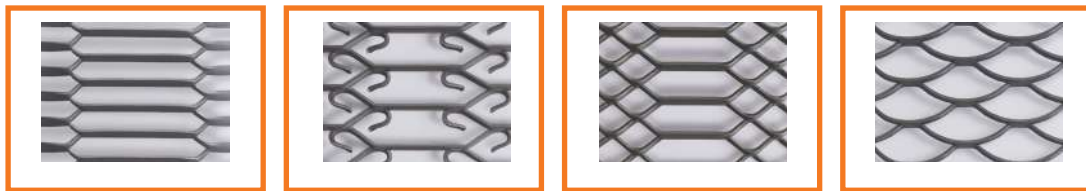

CLÁSICO

GRANADA

GÓTICO

PACÍFICO

REJACERO (PROTECTO REJA)

Combina un diseño atractivo con la fuerza del acero al carbón, elaborado de una sola pieza ofreciendo gran resistencia.
USO: Protección para ventanas, cercas perimetrales, puertas, etc.

REJACERO (PROTECTO REJA)				
MODELO	FIGURA		PESO KG/M2	Medidas aplican a todos los modelos 3" x 8" (.91 m x 2.44m) 4" x 8" (1.22 m x 2.44 m) 8" x 3" (2.44 m x .91 m) 8" x 4" (2.44 m x 1.22 m)
	ANCHO MM	LARGO MM		
Gótico	25	100	7.63	
Granada	25	140	7.63	
Clásico	25	133	7.63	
Pacífico	38	76	5.24	
Barroco	25	100	7.63	

REJACERO

METAL DESPLEGADO

Es una malla metálica formada de una sola pieza, sin costura ni soldadura, que presenta una serie de aberturas de tamaño uniforme en forma de rombos o diamantes.

USO: Protección de maquinaria en movimiento, muebles para jardín, protección de corrientes de alta tensión, guardas protectoras, paneles, divisores de talleres, etc.

REJACERO	
REJ090X244BA	REJACERO 3X8 BARROCO C-11
REJ090X244CLA	REJACERO 3X8 CLASICO C-11
REJ090X244GO	REJACERO 3X8 GOTICA C-11
REJ090X244GR	REJACERO 3X8 GRANADA C-11
REJ090X244PA	REJACERO 3X8 PACIFICO C-11
REJ120X244BA	REJACERO 4X8 BARROCO C-11
REJ120X244CLA	REJACERO 4X8 CLASICO C-11
REJ120X244GO	REJACERO 4X8 GOTICA C-11
REJ120X244GR	REJACERO 4X8 GRANADA C-11
REJ120X244PA	REJACERO 4X8 PACIFICO C-11

METAL PERFORADO

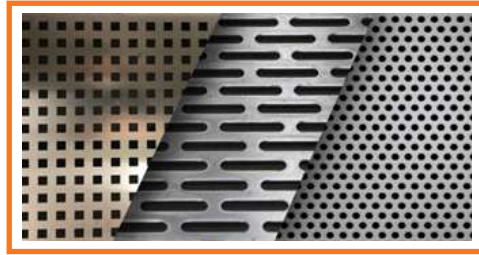

METAL PERFORADO

Son muchas las aplicaciones del metal perforado, Ingenieros, diseñadores y arquitectos encuentran cada vez más usos en sus distintas presentaciones como elementos arquitectónicos, secadores y clasificadores de granos, cribas y tambores, bancas exteriores e interiores, filtros de aire y aceite, cestos y papeleras, rejillas de ventilación, etc.

ESPECIFICACIONES DEL METAL PERFORADO ACERO AL CARBÓN

CATÁLOGO	DIÁMETRO DE LA PERFORACIÓN		DISTANCIA ENTRE CENTROS		PERFORACIONES POR PULGADA 2	ÁREA LIBRE %
	MM.	PULG.	MM.	PULG.		
E062/125	1.6	0.062	3.2	0.125	74	22
E078/137	2.0	0.078	3.5	0.137	62	29
E078/157	2.0	0.078	4.0	0.157	47	22
E093/157	2.4	0.093	4.0	0.157	47	32
E093/250	2.4	0.093	6.4	0.250	18	13
E098/157	2.5	0.098	4.0	0.157	47	35
E118/196	3.0	0.118	5.0	0.196	30	33
E125/187	3.2	0.125	4.7	0.187	33	41
E125/250	3.2	0.125	6.4	0.250	18	23
E157/187	4.0	0.157	4.7	0.187	23	64
E157/250	4.0	0.157	6.4	0.250	18	36
E187/250	4.7	0.187	6.4	0.250	18	51
E196/275	5.0	0.196	7.0	0.275	15	46
E196/314	5.0	0.196	8.0	0.314	12.0	35
E236/314	6.0	0.236	8.0	0.314	12.0	51
E236/354	6.0	0.236	9.0	0.354	9	40
E275/393	7.0	0.275	10.0	0.393	7	44
E314/393	8.0	0.314	10.0	0.393	7	58
E354/472	9.0	0.354	12.0	0.472	5	51
E375/500	9.5	0.375	12.7	0.500	5	51
E393/511	10.0	0.393	13.0	0.511	4	54
E472/629	12.0	0.472	16.0	0.629	3	51
E500/687	12.7	0.500	17.4	0.687	2	48
E750/1000	19.1	0.750	25.4	1.000	1	51
E1000/1500	25.4	1.000	38.1	1.500	0.5	40

* Todos los perforados mencionados en la tabla se ofrecen en varios calibres. Consulte a nuestro Departamento de Servicio para los calibres y materiales disponibles.

Los números de catálogo que se inician con "E" representan distribución de Perforado Escalonado (Staggered).

Las dimensiones estándar de cada producto son de 1 x 2 m.

ESPECIFICACIONES DEL METAL PERFORADO OBLONGO							
CATÁLOGO	DIÁMETRO DE LA PERFORACIÓN		DISTANCIA ENTRE CENTROS		ÁREA LIBRE %	DISTRIBUCIÓN DE PERFORACIONES	CALIBRE ESTÁNDAR
	ANCHO "A" (MM)	LARGO "B" (MM)	"W" (MM)	"Y" (MM)			
SS 1.2 X 5/7 X 7.5	1.2	5	7	7.5	22	SS-LW	20
SS 2.0 X 14/14 X 21	2	14	14	21	18	SS-LW	14
SS 2.5 X 20/14 X 25	2.5	20	14	25	28	SS-LW	18
SS 3.0 X 20/12 X 25	3	20	12	25	40	SS-LW	20
SS 4.0 X 20/16 X 24	4	20	16	24	40	SS-LW	20
SS 6.0 X 20/18 X 25	6	20	18	25	50	SS-LW	22
ES 2.0 X 20/8 X 44	2	20	8	44	22	ES-NW	22
ES 3.0 X 20/11 X 44	3	20	11	44	24	ES-NW	22
ES 4.0 X 20/13 X 44	4	20	13	44	27	ES-NW	20
ES 5.0 X 20/16 X 44	5	20	16	44	28	ES-NW	22
ES 8.0 X 20/25 X 46	8	20	25	46	28	ES-NW	22
ES 9.0 X 30/41 X 70	9	30	41	70	18	ES-NW	22
ES 10.0 X 25/30 X 58	10	25	30	58	26	ES-NW	20

***NOMENCLATURA:**

SS = Lados escalonados ES = Puntas escalonadas LW = Largos de perforación a lo largo de la hoja

NW = Largo de la perforación a lo ancho de la hoja

Notas: Las dimensiones estándar de cada producto son de 1 x 2 metros.

Además de los calibres mencionados en la tabla, también se ofrecen perforados en otros calibres

PLAFONES DECORATIVOS

Están diseñados para suspensiones estándar de 15/16". En diseños de metal perforado, estos plafones crean espacios contemporáneos, dando la sensación de espacios más abiertos. Se ofrecen 2 colores en pintura electrostática, con la opción de desarrollar tonos de acuerdo a sus requerimientos.

PLAFONES DECORATIVOS SKY METAL								
ARTÍCULO	MATERIAL	ESPECIFICACIONES DE PERFORADO	DIMENSIONES	% ÁREA ABIERTA	CALIBRE	SISTEMA DE SUSPENSIÓN	MATERIAL ACÚSTICO	PIEZAS POR CAJA
PERF001	Aluminio	E062/125	2' x 2' pies (61 x 61cm)	22%	0.022"	Suspensión Estandar 15/16"	Soundtex	10
PERF002	Aluminio	E093/157	2' x 2' pies (61 x 61cm)	33%	0.022"			10
PERF003	Aluminio	E118/196	2' x 2' pies (61 x 61cm)	33%	0.022"			10
PERF004	Aluminio	E125/375	2' x 2' pies (61 x 61cm)	11%	0.022"			

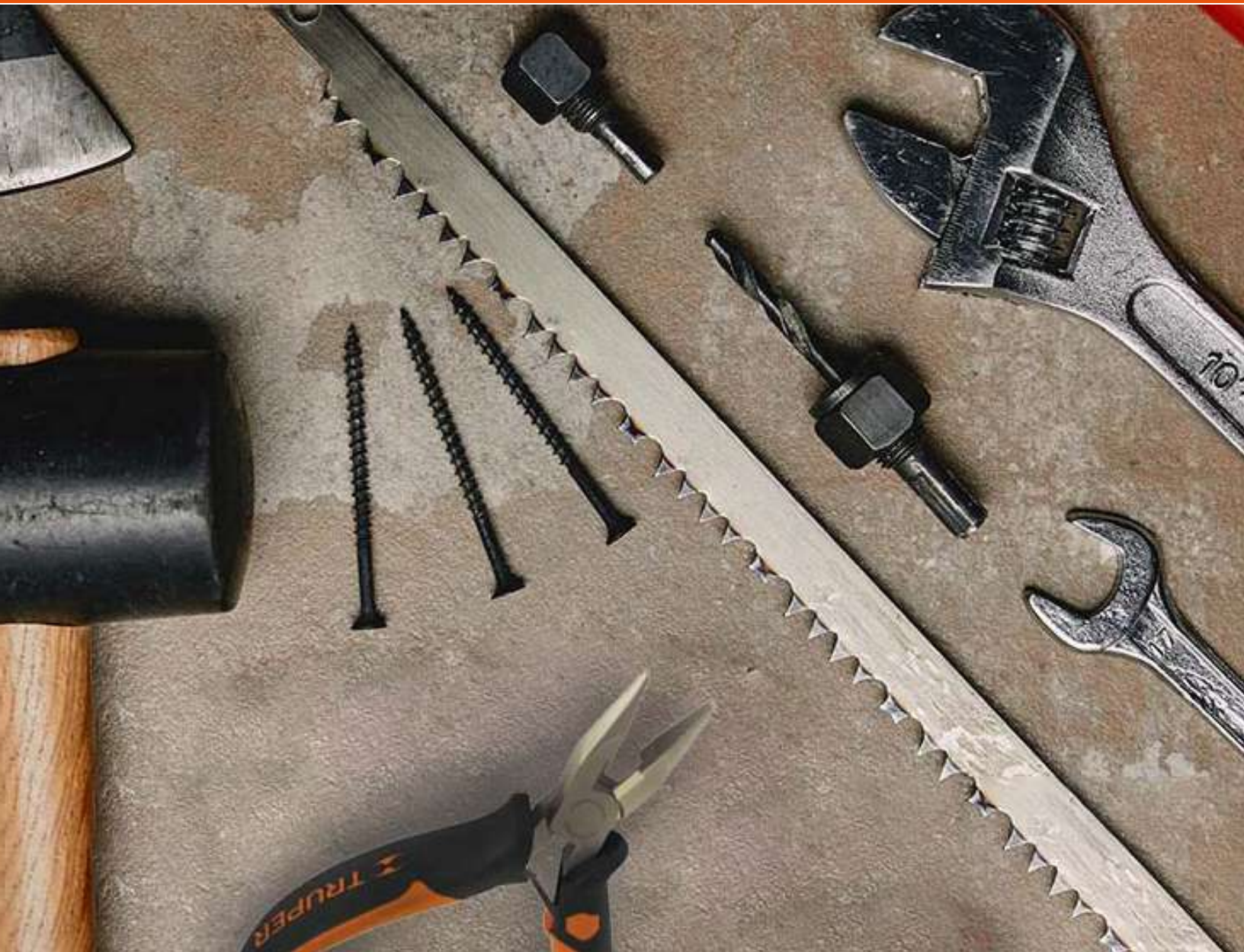

**LÍNEA DE
HERRAMIENTAS
Y ACCESORIOS**

MANERAL PARA MACHUELO EN T



MANERAL PARA MACHUELO EN T	
11438	MANERAL EN T PARA MACHUELO 3/16 MAN-T-3/16
11439	MANERAL EN T PARA MACHUELO 1/4 MAN-T-1/4
11440	MANERAL EN T PARA MACHUELO 1/2 MAN-T-1/2

Manijas deslizables para mayor palanca. Mordaza pavonada anticorrosión tipo broquero. Para machuelos de 3/16" hasta 1/2"

CRAYÓN MARCADOR



CRAYÓN MARCADOR	
CRAYONMAR	CRAYON MARCADOR

Crayón para marcar metal. Tipo jabón. Ideal para herreros, estructureros, lamineros, etc.

PINZA CORTA ELECTRODO



PINZA CORTA ELECTRODO	
14232	PINZA PORTA ELECTRODO DE 300 A PPE-300
14233	PINZA PORTA ELECTRODO DE 500 A PPE-500
24232	PINZA PORTA ELECTRODO DE 300A PPE-300P
24233	PINZA PORTA ELECTRODO DE 500A PPE-500P

Fabricadas de poliéster con recubrimiento de fibra de vidrio resistente a temperaturas elevadas.

Mordazas de latón para una excelente conductividad eléctrica y mayor tiempo de vida. Opresores para sujetar el cable.

TIJERAS HOJALATERO



TIJERAS HOJALATERO	
26050	TIJERA PARA HOJALATERO 10 PRETUL TH-10P
26051	TIJERA PARA HOJALATERO 12 PRETUL TH-12P
26052	TIJERA PARA HOJALATERO DE 8, PRETUL TH-8P

Forjadas de acero al carbono con mangos cubiertos de PVC.

PINZA PARA TIERRA



PINZA PARA TIERRA	
PINZASP/ TIERRAS3	PINZAS PARA TIERRA 300AMP
PINZASP/ TIERRAS5	PINZAS PARA TIERRA 500AMP
24234	PINZA PARA TIERRA 300A PTI-300P
24235	PINZA PARA TIERRA 500A PTI-500P
14234	PINZA PARA TIERRA DE 300 A PTI-300
14235	PINZA PARA TIERRA DE 500 A PTI-500

Pinza de lámina de acero galvanizada, con mordazas de latón y resortes de alta presión para asegurar el contacto.

CABLE PORTA ELECTRODO



CABLE PORTA ELECTRODO	
CAB-PORTA-1/0-A	CABLE PORTAELECTRODO 1/0 AWG
CAB-PORTA-2/0-A	CABLE PORTAELECTRODO 2/0 AWG

PISTOLA DE CALAFATEO PARA SILICÓN



PISTOLA DE CALAFATEO PARA SILICÓN	
17550	PISTOLA CALAFATEADORA TIPO ESQUELETO PICA-E

Pistolas de lámina de acero en acabado esmaltado horneado. Tipo esqueleto, ligera y reforzada.
USO: Pala aplicación de silicón.

BROCAS PARA METAL HSS



BROCAS PARA METAL HSS	
12738	BROCA ALTA VELOCIDAD 3/32 EN BLISTER BAV-3/32-B
12739	BROCA ALTA VELOCIDAD 7/64 EN BLISTER BAV-7/64-B
12740	BROCA ALTA VELOCIDAD 1/8 EN BLISTER BAV-1/8-B
12741	BROCA ALTA VELOCIDAD 9/64 EN BLISTER BAV-9/64-B
12742	BROCA ALTA VELOCIDAD 5/32 EN BLISTER BAV-5/32-B
12743	BROCA ALTA VELOCIDAD 11/64 EN BLISTER BAV-11/64-B
12744	BROCA ALTA VELOCIDAD 3/16 EN BLISTER BAV-3/16-B
12745	BROCA ALTA VELOCIDAD 7/32 EN BLISTER BAV-7/32-B
12746	BROCA ALTA VELOCIDAD 1/4 EN BLISTER BAV-1/4-B
12747	BROCA ALTA VELOCIDAD 5/16 EN BLISTER BAV-5/16-B

Brocas en blister de 1/8" a 5/8" con punta Splint Point Autocentrable para perforaciones más rápidas y precisas.
USO: Madera, Metal y plástico.

BROCA PARA CONCRETO



BROCA PARA CONCRETO	
12752	BROCA PARA CONCRETO 3/16X4 EN BLISTER BCT-3/16X4-B
12753	BROCA PARA CONCRETO 3/16X6 EN BLISTER BCT-3/16X6-B
12754	BROCA PARA CONCRETO 1/4X4 EN BLISTER BCT-1/4X4-B
12756	BROCA PARA CONCRETO 5/16X4 EN BLISTER BCT-5/16X4-B
12757	BROCA PARA CONCRETO 5/16X6 EN BLISTER BCT-5/16X6-B
12758	BROCA PARA CONCRETO 3/8X5 EN BLISTER BCT-3/8X5-B
12759	BROCA PARA CONCRETO 3/8X6 EN BLISTER BCT-3/8X6-B
12760	BROCA PARA CONCRETO 1/2X6 EN BLISTER BCT-1/2X6-B

Brocas para concreto cuerpo de acero al cromo que ofrece mayor resistencia al calentamiento. Punta de carburo de tungsteno que brinda mayor duración. USO: Concreto y ladrillo.

BROCA DE ALTA VELOCIDAD



BROCA DE ALTA VELOCIDAD	
11110	BROCA DE ALTA VELOCIDAD 1/16 BAV-1/16
11112	BROCA DE ALTA VELOCIDAD 5/64 BAV-5/64
11114	BROCA DE ALTA VELOCIDAD 3/32 BAV-3/32
11116	BROCA DE ALTA VELOCIDAD 7/64 BAV-7/64
11118	BROCA DE ALTA VELOCIDAD 1/8 BAV-1/8
11120	BROCA DE ALTA VELOCIDAD 9/64 BAV-9/64
11122	BROCA DE ALTA VELOCIDAD 5/32 BAV-5/32
11124	BROCA DE ALTA VELOCIDAD 11/64 BAV-11/64
11126	BROCA DE ALTA VELOCIDAD 3/16 BAV-3/16
11130	BROCA DE ALTA VELOCIDAD 7/32 BAV-7/32
11132	BROCA DE ALTA VELOCIDAD 15/64 BAV-15/64
11134	BROCA DE ALTA VELOCIDAD 1/4 BAV-1/4
11136	BROCA DE ALTA VELOCIDAD 17/64 BAV-17/64
11138	BROCA DE ALTA VELOCIDAD 9/32 BAV-9/32
11140	BROCA DE ALTA VELOCIDAD 19/64 BAV-19/64
11142	BROCA DE ALTA VELOCIDAD 5/16 BAV-5/16
11144	BROCA DE ALTA VELOCIDAD 21/64 BAV-21/64
11146	BROCA DE ALTA VELOCIDAD 11/32 BAV-11/32
11148	BROCA DE ALTA VELOCIDAD 23/64 BAV-23/64
11150	BROCA DE ALTA VELOCIDAD 3/8 BAV-3/8
11152	BROCA DE ALTA VELOCIDAD 25/64 BAV-25/64
11154	BROCA DE ALTA VELOCIDAD 13/32 BAV-13/32
11156	BROCA DE ALTA VELOCIDAD 27/64 BAV-27/64
11158	BROCA DE ALTA VELOCIDAD 7/16 BAV-7/16
11160	BROCA DE ALTA VELOCIDAD 29/64 BAV-29/64
11162	BROCA DE ALTA VELOCIDAD 15/32 BAV-15/32
11164	BROCA DE ALTA VELOCIDAD 31/64 BAV-31/64
11166	BROCA DE ALTA VELOCIDAD 1/2 BAV-1/2

CADENA ELECTROSOLDADA



CADENA ELECTROSOLDADA	
44274	CADENA GALVANIZADA DE 1/2 CAGA-1/2
44271	CADENA GALVANIZADA DE 1/4 CAGA-1/4
44269	CADENA GALVANIZADA DE 1/8 CAGA-1/8
44270	CADENA GALVANIZADA DE 3/16 CAGA-3/16
44273	CADENA GALVANIZADA DE 3/8 CAGA-3/8
44272	CADENA GALVANIZADA DE 5/16 CAGA-5/16

Fabricada en acero galvanizado, cadena en grado 30 formada en frío, con eslabones electrosoldados.

USO: Limitar accesos, carga de objetos, asegurar rejas y portones.

BROCA PARA CONCRETO



BROCA PARA CONCRETO	
11200	BROCA PARA CONCRETO, 3/16 X 4 BCT-3/16X4
11203	BROCA PARA CONCRETO, 1/4 X 4 BCT-1/4X4
11206	BROCA PARA CONCRETO, 1/4 X 6 BCT-1/4X6
11209	BROCA PARA CONCRETO, 1/4 X 12 BCT-1/4X12
11212	BROCA PARA CONCRETO, 5/16 X 4 BCT-5/16X4
11215	BROCA PARA CONCRETO, 5/16 X 6 BCT-5/16X6
11218	BROCA PARA CONCRETO, 5/16 X 12 BCT-5/16X12
11221	BROCA PARA CONCRETO, 3/8 X 5 BCT-3/8X5
11224	BROCA PARA CONCRETO, 3/8 X 6 BCT-3/8X6
11227	BROCA PARA CONCRETO, 3/8 X 12 BCT-3/8X12
11230	BROCA PARA CONCRETO, 1/2 X 6 BCT-1/2X6
11233	BROCA PARA CONCRETO, 1/2 X 12 BCT-1/2X12
11236	BROCA PARA CONCRETO, 5/8 X 6 BCT-5/8X6
11239	BROCA PARA CONCRETO, 5/8 X 12 BCT-5/8X12
11242	BROCA PARA CONCRETO, 3/4 X 6 BCT-3/4X6
11245	BROCA PARA CONCRETO, 3/4 X 12 BCT-3/4X12
11248	BROCA PARA CONCRETO, 7/8 X 6 BCT-7/8X6
11251	BROCA PARA CONCRETO, 7/8 X 12 BCT-7/8X12
11254	BROCA PARA CONCRETO, 1 X 6 BCT-1X6
11257	BROCA PARA CONCRETO, 1 X 12 BCT-1X12
11258	BROCA PARA CONCRETO, 3/16 X 6 BCT-3/16X6

Cuerpo de acero al cromo que ofrece mayor resistencia al calentamiento.
Punta de carburo de tungsteno que brindan mayor duración
USO: Concreto y ladrillo.

ESLINGA



ESLINGA	
17871	ESLINGA 2 X 10M. ESLI-210
17869	ESLINGA 2 X 6M. ESLI-206
17870	ESLINGA 2 X 8M. ESLI-208
17868	ESLINGA 2X 4M. ESLI-204
17875	ESLINGA 3 X 10M. ESLI-310
17873	ESLINGA 3 X 6M. ESLI-306
17874	ESLINGA 3 X 8M. ESLI-308
17872	ESLINGA 3X 4M. ESLI-304
17879	ESLINGA 4 X 10M. ESLI-410
17877	ESLINGA 4 X 6M. ESLI-406
17878	ESLINGA 4 X 8M. ESLI-408
17876	ESLINGA 4X 4M. ESLI-404

Bandas planas 100% poliéster, alta resistencia a cortes, fricción, abrasión y al desgaste. USO: Levantar y mover cargas pesadas.

MAZO DE HULE



MAZO DE HULE	
20566	MAZO DE HULE, 16 OZ, PRETUL MH-16P
20567	MAZO DE HULE, 24 OZ, PRETUL MH-24P
20565	MAZO DE HULE, 8 OZ, PRETUL MH-8P

Cabezas de neopreno, mango de madera. No dañan la superficie.

MAZO DE HULE



MAZO DE HULE	
16931	MAZO DE HULE 16 OZ MH-16
16932	MAZO DE HULE 24 OZ MH-24
16930	MAZO DE HULE 8 OZ MH-8

Cabezas de hule 100% virgen, blancas que no ensucian y no dañan la superficie. Mangos de madera con grabados láser antiderrapante.

CORTA PERNOS



CORTA PERNOS	
12830	CORTAPERNO 12, CUCHILLA FABRICADA EN ACERO AL SILICIO CP-12X
12831	CORTAPERNO 14, CUCHILLA FABRICADA EN ACERO AL SILICIO CP-14X
12832	CORTAPERNO 18, CUCHILLA FABRICADA EN ACERO AL SILICIO CP-18X
12833	CORTAPERNO 24, CUCHILLA FABRICADA EN ACERO AL SILICIO CP-24X
12834	CORTAPERNO 30, CUCHILLA FABRICADA EN ACERO AL SILICIO CP-30X
12835	CORTAPERNO 36, CUCHILLA FABRICADA EN ACERO AL SILICIO CP-36X

MATERIAL: Acero de alto carbón con aleación de cromo molibdeno y mango de hierro colado

ACABADO: Pintura esmaltada y horneado

MEDIDAS: 14", 18", 24" y 30"

USO: Cortadora de alambre en general

ESCUADRA FALSA



ESCUADRA FALSA	
14382	ESCUADRA PARA CANTERO, 16X24 E-16X24

Regla de acero inoxidable graduada por ambos lados y mango de ABS, graduación en sistema métrico y standard.

ESCUADRA



ESCUADRA	
14384	ESCUADRA PARA CANTERO, 16X24 E-16X24
14386	ESCUADRA PARA CANTERO, 8X12 E-8X12

Regla de acero inoxidable graduada por ambos lados y mango de ABS, graduación en sistema métrico y standard.

ESCUADRA DE COMBINACIÓN



ESCUADRA DE COMBINACIÓN	
14369	ESCUADRA DE COMBINACION, 6 ECT-6
14380	ESCUADRA DE COMBINACION, 12 ECT-12
14381	ESCUADRA DE COMBINACION, 16 ECT-16

Cabezal más robusto, marcado en tinta negra para mayor visibilidad, fácil lectura y punzón para marcar la superficie, graduación estampada en bajo relieve con tinta negra para mejor visibilidad.

LLAVE AJUSTABLE (PERICO)



LLAVE AJUSTABLE (PERICO)	
15508	PERICO 12 CROMADO, GRADO INDUSTRIAL PET-12C
15509	PERICO 6 CROMADO CON GRIP PET-6X
15510	PERICO 8 CROMADO CON GRIP PET-8X
15511	PERICO 10 CROMADO CON GRIP PET-10X
15512	PERICO 12 CROMADO CON GRIP PET-12X

Forjados en acero al carbono con graduación en pulgadas y milímetros. Mangos de PVC con orificio para colgar.

LLAVE AJUSTABLE (PERICO)



PINZA PUNTA Y CORTE



LLAVE AJUSTABLE (PERICO)	
21814	PERICO 6 CROMADO EN BLISTER, PRETUL PET-6PB
21815	PERICO 8 CROMADO EN BLISTER, PRETUL PET-8PB
21816	PERICO 10 CROMADO EN BLISTER, PRETUL PET-10PB
21817	PPERICO 12 CROMADO EN BLISTER, PRETUL PET-12PB

Forjados en acero al carbono con acabado cromo que protege de la corrosión. Mangos con orificio para colgar.

PINZA PUNTA Y CORTE	
17334	PINZA PUNTA Y CORTE 6, MANGO COMFORT GRIP T203-6X
17336	PINZA PUNTA Y CORTE 8, MANGO COMFORT GRIP T203-8X
12348	PINZA PUNTA Y CORTE 7, MGO COMFORT GRIP T203-7X

Fabricadas en acero al cromo vanadio, 2X más resistentes al desgaste que las de acero al carbono
Acabado niquelado gris, 3X más resistente a la corrosión con mangos ergonómicos con topes que evitan el deslizamiento de la mano

PINZAS DE PRESIÓN



PINZAS DE PRESIÓN	
17419	PINZA DE PRESION 4, MORDAZA CURVA PPT-4C
17420	PINZA DE PRESION 5, MORDAZA CURVA PPT-5C
17421	PINZA DE PRESION 7, MORDAZA CURVA PPT-7C
17423	PINZA DE PRESION 10, MORDAZA CURVA PPT-10C
17429	PINZA DE PRESION 12, MORDAZA CURVA PPT-12C

Mordazas curvas de acero al cromo molibdeno, que maximizan los puntos de presión en tornillos y tuercas, cortadores de alambre integrados y mangos con textura antiderrapante.

PINZAS DE PRESIÓN



PINZAS DE PRESIÓN	
17422	PINZA DE PRESION 7, MORDAZA RECTA PPT-7R
17424	PINZA DE PRESION 10, MORDAZA RECTA PPT-10R
17431	PINZA DE PRESION 12, MORDAZA RECTA PPT-12R

Mordazas rectas de acero al cromo molibdeno, que maximizan los puntos de contacto en las superficies de trabajo con mangos con textura antiderrapante.

PINZA DE ELECTRICISTA



PINZA DE ELECTRICISTA	
22603	PINZA LIGERA DE ELECTRICISTA 7, PRETUL PEL-7P
22609	PINZA LIGERA DE ELECTRICISTA 8, PRETUL PEL-8P
22708	PINZA DE ELECTRICISTA 8, PRETUL, GRANEL PEL-8PG

Fabricada en acero al carbono. Mango cubierto de PVC.

FLEXÓMETROS



FLEXÓMETROS	
14577	FLEXOMETRO CONTRA IMPACTO, 3 M FH-3M
14578	FLEXOMETRO CONTRA IMPACTO, 5 M FH-5M
14579	FLEXOMETRO CONTRA IMPACTO, 8 M, ANCHO 1 FH-8M

Caja plástica de color y cinta metálica blanca con doble impresión. Caja de plástico tipo ABS, sistema métrico decimal, cinta blanca con doble impresión, freno y botón de pausa y clip de acero templado y cromado.

REMACHADORA



REMACHADORA	
17960	REMACHADORA 9 PROFESIONAL RE-9
22850	REMACHADORA 10, PRETUL RE-10P

Para remaches de 3/32", 1/8", 5/32" y 3/16"

NIVEL TORPEDO CUERPO DE ALUMINIO



NIVEL TORPEDO CUERPO DE ALUMINIO	
17054	NIVEL TORPEDO 9 MAGNETICO NTX-9

Cuerpo de aluminio de uso rudo con protecciones de TPR/ABS contra impactos.
Gotas resistentes a la abrasión y al impacto.
Ranura en "V" que facilita su uso en tubos y mangueras.

NIVEL TORPEDO



NIVEL TORPEDO	
22450	NIVEL TORPEDO 9, PRETUL NT-9P

Ventana de lectura superior, gotas resistentes a la abrasión y al impacto.

NIVEL CLÁSICO



NIVEL CLÁSICO	
17030	NIVEL 12 CLASICO NP-12
17032	NIVEL 14 CLASICO NP-14

Cuerpos de aluminio tipo vigueta con protecciones de ABS contra impacto
Gotas reemplazables, de color verde para mayor visibilidad.

PUNZÓN PARA BARRENAR



PUNZÓN PARA BARRENAR	
12218	PUNZON 1/4 PARA MARCAR, LARGO 4-1/4 PUMAR-1/4
12219	PUNZON 5/16 PARA MARCAR, LARGO 4-5/8 PUMAR-5/16
12220	PUNZON 3/8 PARA MARCAR, LARGO 4-7/8 PUMAR-3/8
12221	PUNZON PARA MARCAR DE 7/16 PUMAR-7/16
12222	PUNZON 1/2 PARA MARCAR, LARGO 5-1/2 PUMAR-1/2
12223	PUNZON 5/8 PARA MARCAR, LARGO 6-1/8 PUMAR-5/8

Fabricados en acero al cromo vanadio
Ángulo de 90° en la punta lo cual les permite dejar una huella visible en la superficie que se aplica.

RONDANAS DE ACERO PLANAS



RONDANAS DE ACERO PLANAS	
FH-RP03	KG RONDANA PLANA 1/8
FH-RP05	KG RONDANA PLANA 3/16
FH-RP06	KG RONDANA PLANA 1/4
FH-RP08	KG RONDANA PLANA 5/16
FH-RP09	KG RONDANA PLANA 3/8
FH-RP11	KG RONDANA PLANA 7/16
FH-RP14	KG RONDANA PLANA 9/16
FH-RP16	KG RONDANA PLANA 5/8
FH-RP19	KG RONDANA PLANA 3/4
FH-RP22	KG RONDANA PLANA 7/8

Rondanas de acero planas de acero 1010 acabado galvanizado y negro
USO: Diversos en tornillería.

RONDANAS DE PRESIÓN



RONDANAS DE PRESIÓN	
RONPRE1	RONDANA DE PRESION 1

Rondanas de presión de acero 1040 en acabado negro y galvanizado.
USO: Diversos en tornillería.

TAQUETES DE PLÁSTICO



TAQUETES DE PLÁSTICO	
44201	TAQUETES DE PLASTICO, 3/8 BOLSA CON 50 PIEZAS TAQ-3/8P
44200	TAQUETES DE PLASTICO, 5/16 BOLSA CON 50 PIEZAS TAQ-5/16P

Fabricados de polietileno
Andas que evitan el giro
Cinturones de resistencia y andas retráctiles de fijación.
USO: Ideales para instalaciones a la intemperie por su resistencia a la humedad

ARCO PARA SEGUETA



ARCO PARA SEGUETAS	
10230	ARCO PROFESIONAL DE SOLERA PARA SEGUETA 12 APT-12
10234	ARCO PROFESIONAL TUBULAR PARA SEGUETA 12 ATT-12

Rondanas de presión de acero 1040 en acabado negro y galvanizado.
USO: Diversos en tornillería.

TAQUETE DE EXPANSIÓN



TAQUETE DE EXPANSIÓN	
TAEXTR250X2.5	TAQUETE EXPANSION TROP 1/4 X 2 1/2 (RH)
TAEXTR188X2.0	TAQUETE EXPANSION TROP 3/16 X 2 (RH)

Taquete Expansivo para fijación de mayor seguridad, eficaz y muy útil. Material 100% de alta calidad y resistencia..

TAQUETE DE EXPANSIÓN CON TORNILLO



TAQUETE DE EXPANSIÓN CON TORNILLO	
44360	TAQUETE EXPANSIVO CON TORNILLO, MEDIDA 1/4 TAE-1/4T
44361	TAQUETE EXPANSIVO CON TORNILLO, MEDIDA 5/16 TAE-5/16T

Fabricados de acero con acabado galvanizado. Taquete montado para fijar en concreto.

TAQUETE DE EXPANSIÓN



TAQUETE DE EXPANSIÓN CON TORNILLO	
44362	TAQUETE EXPANSIVO SIN TORNILLO, MEDIDA 1/4 TAE-1/4
44363	TAQUETE EXPANSIVO SIN TORNILLO, MEDIDA 5/16 TAE-5/16
44364	TAQUETE EXPANSIVO SIN TORNILLO, MEDIDA 3/8 TAE-3/8

Cuerpo metálico con anillo de retención de acero, taquete montado. Para fijar en concreto.

TORNILLO TIPO COCHE



TORNILLO TIPO COCHE	
44710P	TORNILLO COCHE GALVANIZADO, 1/4 X 1/2 TORC-1/4X1/2 (PIEZA)
44711P	TORNILLO COCHE GALVANIZADO, 1/4 X 3/4 TORC-1/4X3/4 (PIEZA)
44712P	TORNILLO COCHE GALVANIZADO, 1/4 X 1 TORC-1/4X1 (PIEZA)
44713P	TORNILLO COCHE GALVANIZADO, 1/4 X 1 1/4 TORC-1/4X1-1/4 (PIEZA)
44714P	TORNILLO COCHE GALVANIZADO, 1/4 X 1 1/2 TORC-1/4X1-1/2 (PIEZA)
44715P	TORNILLO COCHE GALVANIZADO, 1/4 X 2 TORC-1/4X2 (PIEZA)
44716P	TORNILLO COCHE GALVANIZADO, 1/4 X 2 1/2 TORC-1/4X2-1/2 (PIEZA)
44717P	TORNILLO COCHE GALVANIZADO, 1/4 X 3 TORC-1/4X3 (PIEZA)
44718P	TORNILLO COCHE GALVANIZADO, 5/16 X 1/2 TORC-5/16X1/2 (PIEZA)
44719P	TORNILLO COCHE GALVANIZADO, 5/16 X 3/4 TORC-5/16X3/4 (PIEZA)
44720P	TORNILLO COCHE GALVANIZADO, 5/16 X 1 TORC-5/16X1 (PIEZA)
44721P	TORNILLO COCHE GALVANIZADO, 5/16 X 1 1/4 TORC-5/16X1-1/4 (PIEZA)
44722P	TORNILLO COCHE GALVANIZADO, 5/16 X 1 1/2 TORC-5/16X1-1/2 (PIEZA)
44723P	TORNILLO COCHE GALVANIZADO, 5/16 X 2 TORC-5/16X2 (PIEZA)
44724P	TORNILLO COCHE GALVANIZADO, 5/16 X 2 1/2 TORC-5/16X2-1/2 (PIEZA)
44725P	TORNILLO COCHE GALVANIZADO, 5/16 X 3 TORC-5/16X3 (PIEZA)
44726P	TORNILLO COCHE GALVANIZADO, 5/16 X 3 1/2 TORC-5/16X3-1/2 (PIEZA)
44727P	TORNILLO COCHE GALVANIZADO, 5/16 X 4 TORC-5/16X4 (PIEZA)
44728P	TORNILLO COCHE GALVANIZADO, 3/8 X 3/4 TORC-3/8X3/4 (PIEZA)
44729P	TORNILLO COCHE GALVANIZADO, 3/8 X 1 TORC-3/8X1 (PIEZA)
44730P	TORNILLO COCHE GALVANIZADO, 3/8 X 1 1/4 TORC-3/8X1-1/4 (PIEZA)
44731P	TORNILLO COCHE GALVANIZADO, 3/8 X 1 1/2 TORC-3/8X1-1/2 (PIEZA)
44732P	TORNILLO COCHE GALVANIZADO, 3/8 X 2 TORC-3/8X2 (PIEZA)
44733P	TORNILLO COCHE GALVANIZADO, 3/8 X 2 1/2 TORC-3/8X2-1/2 (PIEZA)
44734P	TORNILLO COCHE GALVANIZADO, 3/8 X 3 TORC-3/8X3 (PIEZA)
44735P	TORNILLO COCHE GALVANIZADO, 3/8 X 3 1/2 TORC-3/8X3-1/2 (PIEZA)
44736P	TORNILLO COCHE GALVANIZADO, 3/8 X 4 TORC-3/8X4 (PIEZA)
44739P	TORNILLO COCHE GALVANIZADO, 7/16 X 1 1/2 TORC-7/16X1-1/2 (PIEZA)
44740P	TORNILLO COCHE GALVANIZADO, 7/16 X 2 TORC-7/16X2 (PIEZA)
44741P	TORNILLO COCHE GALVANIZADO, 7/16 X 2 1/2 TORC-7/16X2-1/2 (PIEZA)
44742P	TORNILLO COCHE GALVANIZADO, 7/16 X 3 TORC-7/16X3 (PIEZA)
44743P	TORNILLO COCHE GALVANIZADO, 7/16 X 3 1/2 TORC-7/16X3-1/2 (PIEZA)
44744P	TORNILLO COCHE GALVANIZADO, 7/16 X 4 TORC-7/16X4 (PIEZA)
44745P	TORNILLO COCHE GALVANIZADO, 1/2 X 1 TORC-1/2X1 (PIEZA)
44746P	TORNILLO COCHE GALVANIZADO, 1/2 X 1 1/4 TORC-1/2X1-1/4 (PIEZA)
44747P	TORNILLO COCHE GALVANIZADO, 1/2 X 1 1/2 TORC-1/2X1-1/2 (PIEZA)
44748P	TORNILLO COCHE GALVANIZADO, 1/2 X 2 TORC-1/2X2 (PIEZA)
44749P	TORNILLO COCHE GALVANIZADO, 1/2 X 2 1/2 TORC-1/2X2-1/2 (PIEZA)
44751P	TORNILLO COCHE GALVANIZADO, 1/2 X 3 TORC-1/2X3 (PIEZA)
44751P	TORNILLO COCHE GALVANIZADO, 1/2 X 3 1/2 TORC-1/2X3-1/2 (PIEZA)
44752P	TORNILLO COCHE GALVANIZADO, 1/2 X 4 TORC-1/2X4 (PIEZA)

Fabricados en acero con recubrimiento galvanizado. Cuellos cuadrados.
USO: Fijación de cercas, muebles metálicos, fijación de placas base, etc.

TORNILLO DE ACERO

Fabricados de acero medio carbono, acabado pavonado. Cabeza hexagonal. Permite sujetar y fijar uniones de elementos desmontables donde se necesite soportar una mayor resistencia.



TORNILLO DE ACERO	
44763P	TORNILLO DE ACERO, GRADO 5, 1/4 X 1/2 TOR5-1/4X1/2 (PIEZA)
44764P	TORNILLO DE ACERO, GRADO 5, 1/4 X 3/4 TOR5-1/4X3/4 (PZA)
44765P	TORNILLO DE ACERO, GRADO 5, 1/4 X 1 TOR5-1/4X1 (PIEZA)
44766P	TORNILLO DE ACERO, GRADO 5, 1/4 X 1 1/4 TOR5-1/4X1-1/4 (PIEZA)
44767P	TORNILLO DE ACERO, GRADO 5, 1/4 X 1 1/2 TOR5-1/4X1-1/2 (PIEZA)
44768P	TORNILLO DE ACERO, GRADO 5, 1/4 X 2 TOR5-1/4X2 (PIEZA)
44769P	TORNILLO DE ACERO, GRADO 5, 1/4 X 2 1/2 TOR5-1/4X2-1/2 (PIEZA)
44770P	TORNILLO DE ACERO, GRADO 5, 1/4 X 3 TOR5-1/4-X3 (PIEZA)
44771P	TORNILLO DE ACERO, GRADO 5, 5/16 X 1/2 TOR5-5/16X1/2 (PIEZA)
44772P	TORNILLO DE ACERO, GRADO 5, 5/16 X 3/4 TOR5-5/16X3/4 (PIEZA)
44773P	TORNILLO DE ACERO, GRADO 5, 5/16 X 1 TOR5-5/16X1 (PIEZA)
44774P	TORNILLO DE ACERO, GRADO 5, 5/16 X 1 1/4 TOR5-5/16X1-1/4 (PIEZA)
44775P	TORNILLO DE ACERO, GRADO 5, 5/16 X 1 1/2 TOR5-5/16X1-1/2 (PIEZA)
44776P	TORNILLO DE ACERO, GRADO 5, 5/16 X 2 TOR5-5/16X2 (PIEZA)
44777P	TORNILLO DE ACERO, GRADO 5, 5/16 X 2 1/2 TOR5-5/16X2-1/2 (PIEZA)
44778P	TORNILLO DE ACERO, GRADO 5, 5/16 X 3 TOR5-5/16X3 (PIEZA)
44779P	TORNILLO DE ACERO, GRADO 5, 5/16 X 3 1/2 TOR5-5/16X3-1/2 (PIEZA)
44780P	TORNILLO DE ACERO, GRADO 5, 5/16 X 4 TOR5-5/16X4 (PIEZA)
44781P	TORNILLO DE ACERO, GRADO 5, 3/8 X 3/4 TOR5-3/8X3/4 (PIEZA)
44782P	TORNILLO DE ACERO, GRADO 5, 3/8 X 1 TOR5-3/8X1 (PIEZA)
44783P	TORNILLO DE ACERO, GRADO 5, 3/8 X 1 1/4 TOR5-3/8X1-1/4 (PIEZA)
44784P	TORNILLO DE ACERO, GRADO 5, 3/8 X 1 1/2 TOR5-3/8X1-1/2 (PIEZA)
44785P	TORNILLO DE ACERO, GRADO 5, 3/8 X 2 TOR5-3/8X2 (PIEZA)
44786P	TORNILLO DE ACERO, GRADO 5, 3/8 X 2 1/2 TOR5-3/8X2-1/2 (PIEZA)
44787P	TORNILLO DE ACERO, GRADO 5, 3/8 X 3 TOR5-3/8X3 (PIEZA)
44788P	TORNILLO DE ACERO, GRADO 5, 3/8 X 3 1/2 TOR5-3/8X3-1/2 (PIEZA)
44789P	TORNILLO DE ACERO, GRADO 5, 3/8 X 4 TOR5-3/8X4 (PIEZA)
44790P	TORNILLO DE ACERO, GRADO 5, 7/16 X 1 TOR5-7/16X1 (PIEZA)
44791P	TORNILLO DE ACERO, GRADO 5, 7/16 X 1 1/4 TOR5-7/16X1-1/4 (PIEZA)
44792P	TORNILLO DE ACERO, GRADO 5, 7/16 X 1 1/2 TOR5-7/16X1-1/2 (PIEZA)
44793P	TORNILLO DE ACERO, GRADO 5, 7/16 X 2 TOR5-7/16X2 (PIEZA)
44794P	TORNILLO DE ACERO, GRADO 5, 7/16 X 2 1/2 TOR5-7/16X2-1/2 (PIEZA)
44795P	TORNILLO DE ACERO, GRADO 5, 7/16 X 3 TOR5-7/16X3 (PIEZA)
44796P	TORNILLO DE ACERO, GRADO 5, 7/16 X 3 1/2 TOR5-7/16X3-1/2 (PIEZA)
44797P	TORNILLO DE ACERO, GRADO 5, 7/16 X 4 TOR5-7/16X4 (PIEZA)
44798P	TORNILLO DE ACERO, GRADO 5, 1/2 X 1 TOR5-1/2X1 (PIEZA)
44799P	TORNILLO DE ACERO, GRADO 5, 1/2 X 1 1/4 TOR5-1/2X1-1/4 (PIEZA)
44800P	TORNILLO DE ACERO, GRADO 5, 1/2 X 1 1/2 TOR5-1/2X1-1/2 (PIEZA)
44801P	TORNILLO DE ACERO, GRADO 5, 1/2 X 2 TOR5-1/2X2 (PIEZA)
44802P	TORNILLO DE ACERO, GRADO 5, 1/2 X 2 1/2 TOR5-1/2-X2-1/2 (PIEZA)
44803P	TORNILLO DE ACERO, GRADO 5, 1/2 X 3 TOR5-1/2X3 (PIEZA)
44804P	TORNILLO DE ACERO, GRADO 5, 1/2 X 3 1/2 TOR5-1/2X3-1/2 (PIEZA)
44805P	TORNILLO DE ACERO, GRADO 5, 1/2 X 4 TOR5-1/2X4 (PIEZA)

TORNILLO TIPO ESTUFA



TORNILLO TIPO ESTUFA	
44599P	TORNILLO TIPO ESTUFA 1/8 X 1/2 TORE-1/8X1/2 (PIEZA)
44600P	TORNILLO TIPO ESTUFA 1/8 X 5/8 TORE-1/8X5/8 (PZA)
44601P	TORNILLO TIPO ESTUFA 1/8 X 3/4 TORE-1/8X3/4 (PZA)
44602P	TORNILLO TIPO ESTUFA 1/8 X 1 TORE-1/8X1 (PZA)
44603P	TORNILLO TIPO ESTUFA 1/8 X 1 1/4 TORE-1/8X1-1/4 (PZA)
44604P	TORNILLO TIPO ESTUFA 1/8 X 1 1/2 TORE-1/8X1-1/2 (PIEZA)
44605P	TORNILLO TIPO ESTUFA 1/8 X 2 TORE-1/8X2 (PIEZA)
44606P	TORNILLO TIPO ESTUFA 5/32 X 1/2 TORE-5/32X1/2 (PZA)
44607P	TORNILLO TIPO ESTUFA 5/32 X 5/8 TORE-5/32X5/8 (PIEZA)
44608P	TORNILLO TIPO ESTUFA 5/32 X 3/4 TORE-5/32X3/4 (PIEZA)
44609P	TORNILLO TIPO ESTUFA 5/32 X 1 TORE-5/32X1 (PIEZA)
44610P	TORNILLO TIPO ESTUFA 5/32 X 1 1/4 TORE-5/32X1-1/4 (PIEZA)
44611P	TORNILLO TIPO ESTUFA 5/32 X 1 1/2 TORE-5/32X1-1/2 (PIEZA)
44612P	TORNILLO TIPO ESTUFA 5/32 X 2 TORE-5/32X2(PZA)
44613P	TORNILLO TIPO ESTUFA 5/32 X 2 1/2 TORE-5/32X2-1/2 (PIEZA)
44614P	TORNILLO TIPO ESTUFA 3/16 X 1/2 TORE-3/16X1/2 (PZA)
44615P	TORNILLO TIPO ESTUFA 3/16 X 5/8 TORE-3/16X5/8 (PZA)
44616P	TORNILLO TIPO ESTUFA 3/16 X 3/4 TORE-3/16X3/4 (PZA)
44617P	TORNILLO TIPO ESTUFA 3/16 X 1 TORE-3/16X1 (PIEZA)
44618P	TORNILLO TIPO ESTUFA 3/16 X 1 1/4 TORE-3/16X1-1/4 (PIEZA)
44619P	TORNILLO TIPO ESTUFA 3/16 X 1 1/2 TORE-3/16X1-1/2 (PIEZA)
44620P	TORNILLO TIPO ESTUFA 3/16 X 2 TORE-3/16X2 (PZA)
44621P	TORNILLO TIPO ESTUFA 3/16 X 2 1/2 TORE-3/16X2-1/2 (PIEZA)
44622P	TORNILLO TIPO ESTUFA 3/16 X 3 TORE-3/16X3 (PIEZA)
44623P	TORNILLO TIPO ESTUFA 1/4 X 1/2 TORE-1/4X1/2 (PIEZA)
44624P	TORNILLO TIPO ESTUFA 1/4 X 5/8 TORE-1/4X5/8 (PIEZA)
44625P	TORNILLO TIPO ESTUFA 1/4 X 3/4 TORE-1/4X3/4 (PIEZA)
44626P	TORNILLO TIPO ESTUFA 1/4 X 1 TORE-1/4X1 (PIEZA)
44627P	TORNILLO TIPO ESTUFA 1/4 X 1 1/4 TORE-1/4X1-1/4 (PIEZA)
44628P	TORNILLO TIPO ESTUFA 1/4 X 1 1/2 TORE-1/4X1-1/2 (PIEZA)
44629P	TORNILLO TIPO ESTUFA 1/4 X 2 TORE-1/4X2 (PIEZA)
44630P	TORNILLO TIPO ESTUFA 1/4 X 2 1/2 TORE-1/4X2-1/2 (PIEZA)
44631P	TORNILLO TIPO ESTUFA 1/4 X 3 TORE-1/4X3 (PZA)

Fabricados de acero medio carbono, acabado pavonado. Cabeza hexagonal. Permite sujetar y fijar uniones de elementos desmontables donde se necesite soportar una mayor resistencia.



TRUPER

DISTRIBUIDOR

AUTORIZADO



aceros lasa | LÍNEA DE HERRAMIENTAS Y ACCESORIOS

www.aceroslasa.com cotizaciones: 777 326 62 24 / contacto@aceroslasa.com

MEDIOS DE CONTACTO

CEDIS MORELOS

MATRIZ

 Dirección: C. Fortalecimiento Municipal S/N, Las Animas, Temixco, Mor, CP: 62583.

 Teléfono: (777) 326 5274 - (777) 326 6224

 Correo: cuernavaca@aceroslasa.com

 WhastApp: 777 420 7231

CEDIS ACAPULCO

SABANA

 Dirección: Acapulco-Pinotepa Nacional 85, Ruffo Figueroa, La Sabana, Acapulco de Juárez, Gro CP: 39799.

 Teléfono: (744) 441 2050 - (744) 441 1868.

 Correo: sabana@aceroslasa.com

 WhastApp: 744 254 07 03

COLOSO

 Dirección: Carr. Cayaco - Puerto Marqués 3, El Coloso, Acapulco de Juárez, Gro, CP: 39810.

 Teléfono: (744) 433 8365 - (744) 468 0018.

 Correo: sabana@aceroslasa.com

 WhastApp: 744 254 07 03

